

# **2-Wire VTH5222CH User's Manual**

V1.0.0

## Table of Contents

1	General Introduction .....	5
1.1	Front Panel .....	5
1.2	Rear Panel.....	5
2	Installation .....	7
2.1	Install Device .....	7
2.1.1	Metal Embedded Case .....	7
2.1.2	Direct Installation.....	8
2.2	Cable Connection .....	9
3	Basic Config .....	10
3.1	Networking.....	10
3.2	Device Config .....	10
3.3	Config Complete .....	14
4	Product Function.....	16
4.1	Homepage .....	16
4.2	Settings.....	17
4.2.1	User Settings.....	17
4.2.2	Project Settings .....	23
4.2.3	Time Settings .....	28
4.2.4	Introduction.....	29
4.2.5	Info Initialization.....	29
4.3	Call .....	30
4.3.1	Call Resident.....	30
4.3.2	Contact.....	32
4.3.3	Call Record.....	34
4.4	SOS Call.....	35
4.5	Monitor.....	36
4.6	Alarm .....	37
4.6.1	Zone Setting .....	37
4.6.2	Mode Setting .....	39
4.6.3	Arm/Disarm .....	40

4.6.4 Alarm Record .....	42
4.7 Info Search .....	42
4.8 Unlock.....	43
Appendix 1 Technical Specifications.....	44

## Important Safeguards and Warnings

Please read the following safeguards and warnings carefully before using the product in order to avoid damages and losses.

Note:

- Do not expose the device to lampblack, steam or dust. Otherwise it may cause fire or electric shock.
- Do not install the device at position exposed to sunlight or in high temperature. Temperature rise in device may cause fire.
- Do not expose the device to humid environment. Otherwise it may cause fire.
- The device must be installed on solid and flat surface in order to guarantee safety under load and earthquake. Otherwise, it may cause device to fall off or turnover.
- Do not place the device on carpet or quilt.
- Do not block air vent of the device or ventilation around the device. Otherwise, temperature in device will rise and may cause fire.
- Do not place any object on the device.
- Do not disassemble the device without professional instruction.

Warning:

- Please use battery properly to avoid fire, explosion and other dangers.
- Please replace used battery with battery of the same type.
- Do not use power line other than the one specified. Please use it properly. Otherwise, it may cause fire or electric shock.

## Special Announcement

- This manual is for reference only.
- All the designs and software here are subject to change without prior written notice.
- All trademarks and registered trademarks are the properties of their respective owners.
- If there is any uncertainty or controversy, please refer to the final explanation of us.
- Please visit our website for more information.

# 1 General Introduction

## 1.1 Front Panel

See Figure 1-1.

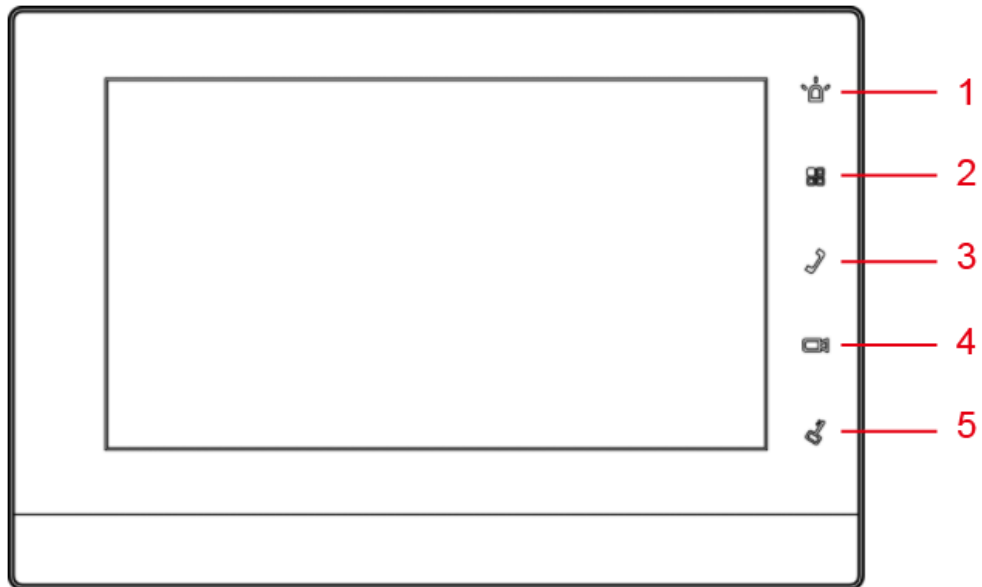

Figure 1-1

No.	Parameter	Note
1	SOS	Emergent call to center.
2	Arm/Main menu	Click this button to return to main menu.
3	Call	Under calling, status, click this button to answer call. During a call, click this button to hang up.
4	Monitor	Monitor VTO video.
5	Unlock	Monitor VTO video.
		During incoming call, calling, monitoring status, click this button to unlock.

Chart 1-1

## 1.2 Rear Panel

See Figure 1-2.

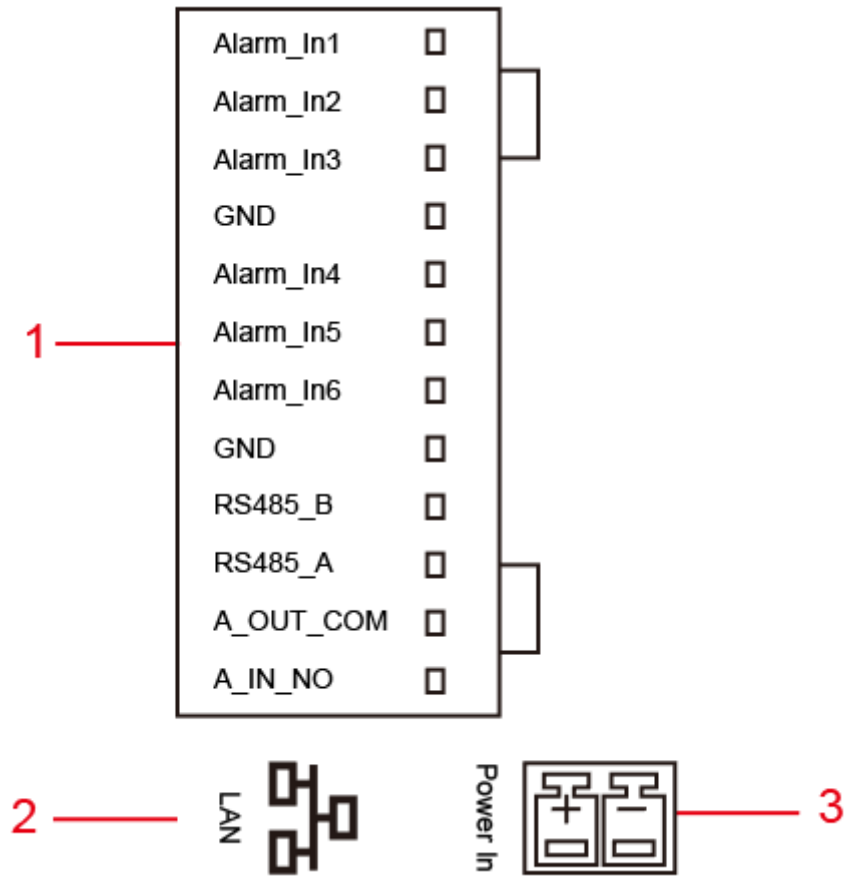

Figure 1-2

No.	Port	Note
<b>1</b>	12-pin Port	Alarm input 1. Alarm input 2. Alarm input 3. GND. Alarm input 4. Alarm input 5. Alarm input 6. GND. RS485A port. RS485B port. Alarm output port COM (standard N/A) . Alarm output port NO (standard N/A) .
<b>2</b>	Network Port	Plug in RJ45 Ethernet cable
<b>3</b>	Power Port	2-pin green 12V power.

Chart 1-2

# 2 Installation

## 2.1 Install Device

### Warning:

- Avoid installation in poor environment, such as condensation, high temperature, oil stain, dust, corrosion or direct sunlight.
- After device is plugged to power, if you find any abnormal phenomenon, you shall immediately unplug network cable and cut power supply. You may re-plug in power after troubleshooting.
- Project installation and debugging must be done by professionals. Please do not open the device in case of failure, and please contact after sales service.

This device support direct installation and metal embedded case installation.

See Chart 2-1.

Component Name	Diagram	Quantity
M4×30 cross pan head screw		3

Chart 2-1

### 2.1.1 Metal Embedded Case

Step 1. Embed metal case into wall at appropriate height.

Note:

Recommended distance from device center to ground is 1400mm~1600mm.

Step 2. Install installation bracket on metal case, fixed with screw.

Step 3. Fix the device unit on installation bracket, fixed with buckle.

See Figure 2-1.

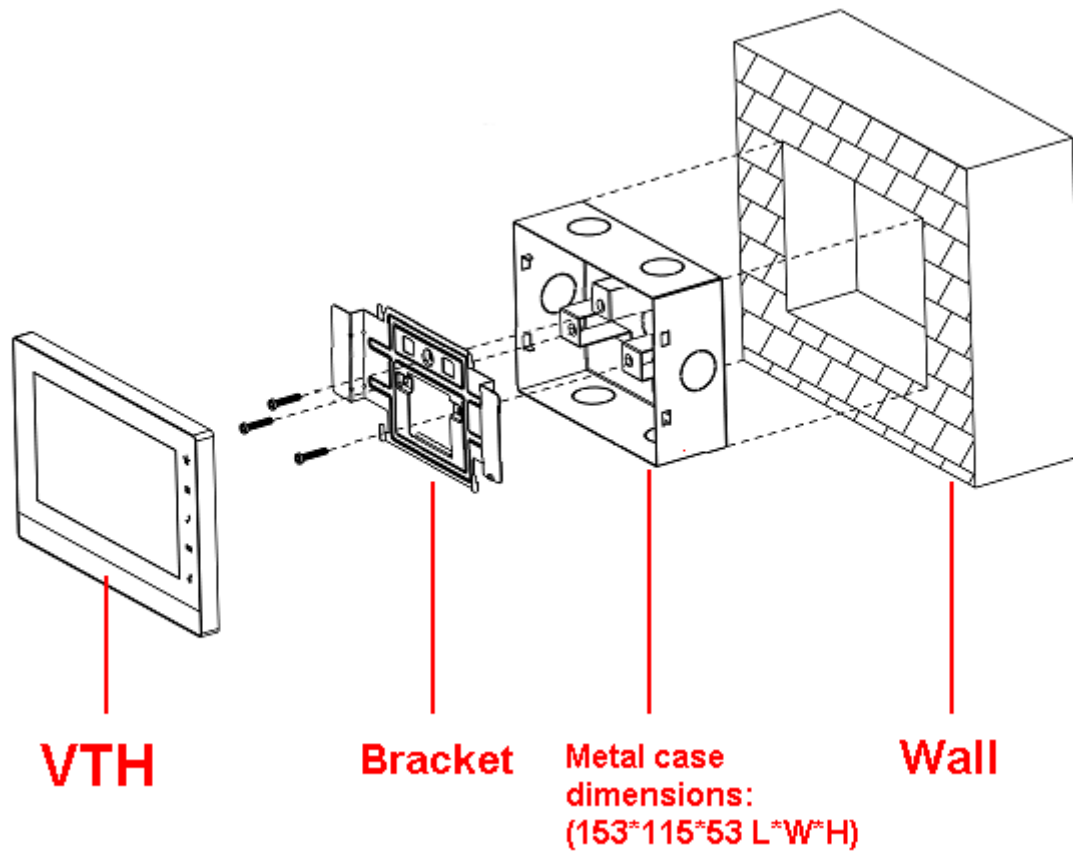

Figure 2-1

### 2.1.2 Direct Installation

Direct installation is to pull all wiring from side of device without digging holes on wall for wiring.

Step 1. Fix installation bracket on wall with screw.

Step 2. Fix device on installation bracket and buckle it. See Figure 2-2.



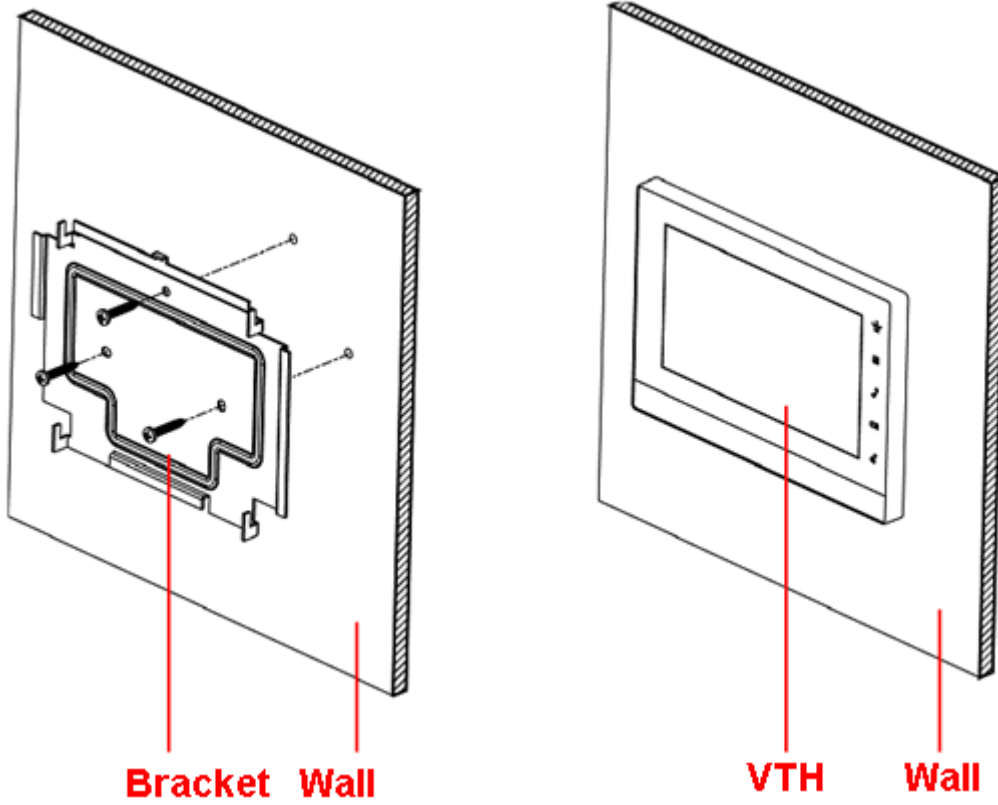

Figure 2-2

## 2.2 Cable Connection

Please see Ch 1.2.

# 3 Basic Config

Quickly configure VTH and VTO to fulfill real-time talk, monitor and etc.

Note:

In Project Setup page (for engineer only), password to enter is 888888.

## 3.1 Networking

See Figure 3-1.

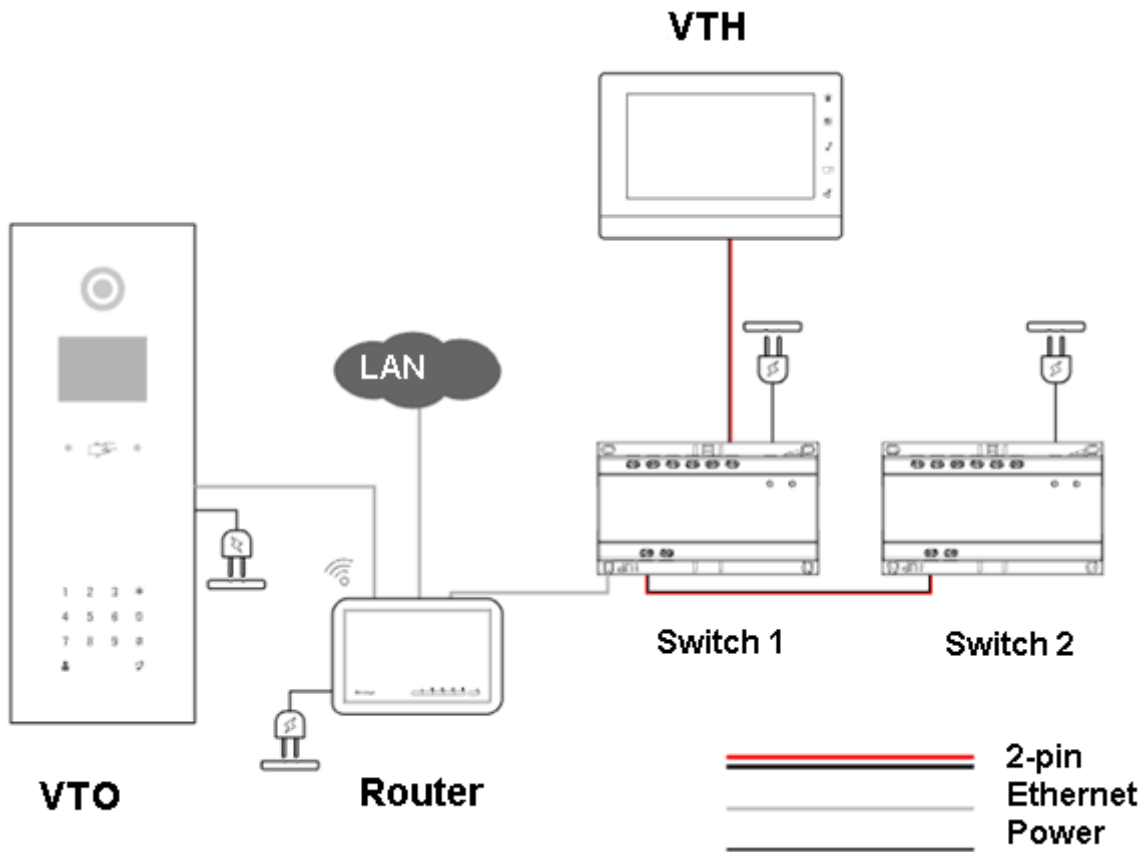

Figure 3-1

## 3.2 Device Config

Step 1. In Project Settings interface, select System Settings>Project Settings.

Step 2. Enter password (888888 by default) to enter Project Settings interface. See Figure 3-2.

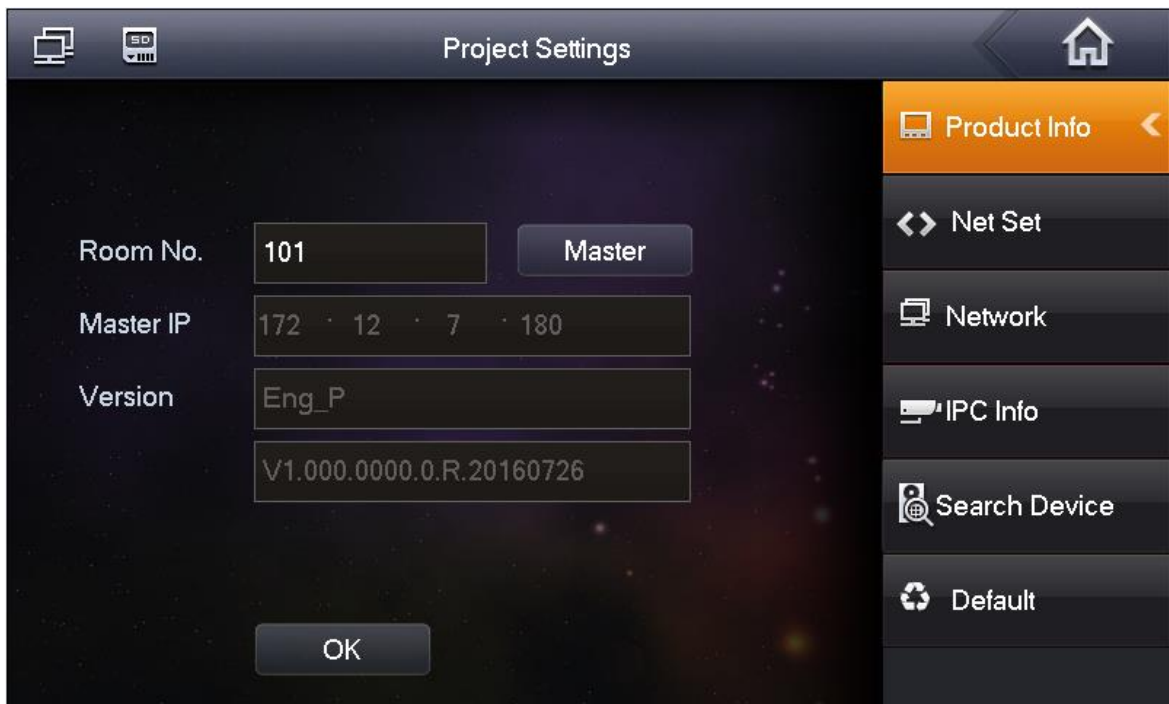

Figure 3-2

Step 3. Set VTH room no.

Warning:

VTH room no. must match VTH shirt no. of corresponding VTO WEB.

- If this VTH is master VTH.
  1. Fill in room no.
  2. Click OK to save.
- If this VTH is extension, click Master, select Extension.
  1. Fill in room no., and master IP.  
See Figure 3-3.

Note:

Part of VTH extension config will be synced with master VTH, which cannot be modified.

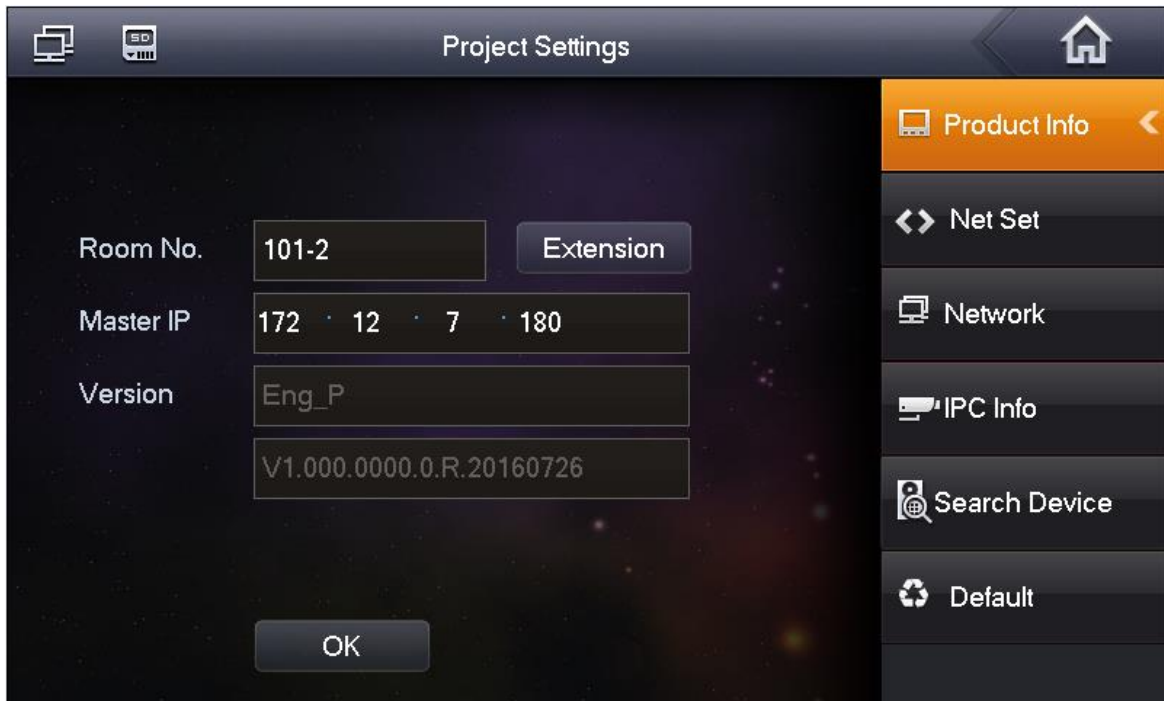

Figure 3-3

2. Click OK to save.

Step 4. Set VTH network.

Click Network, system shows Network interface.

- Select static IP, manually enter device IP, subnet mask, gateway and etc.
- Select DHCP, auto get device IP, subnet mask, gateway and etc.

Note:

Telnet server is ON, debugging personnel can login via telnet+IP to view VTH config.

Step 5. Add VTO info.

1. By Terminal.  
System shows network terminal interface.
2. Fill in VTO name, VTO IP address, and set Enable Status to ON, see Figure 3-4.

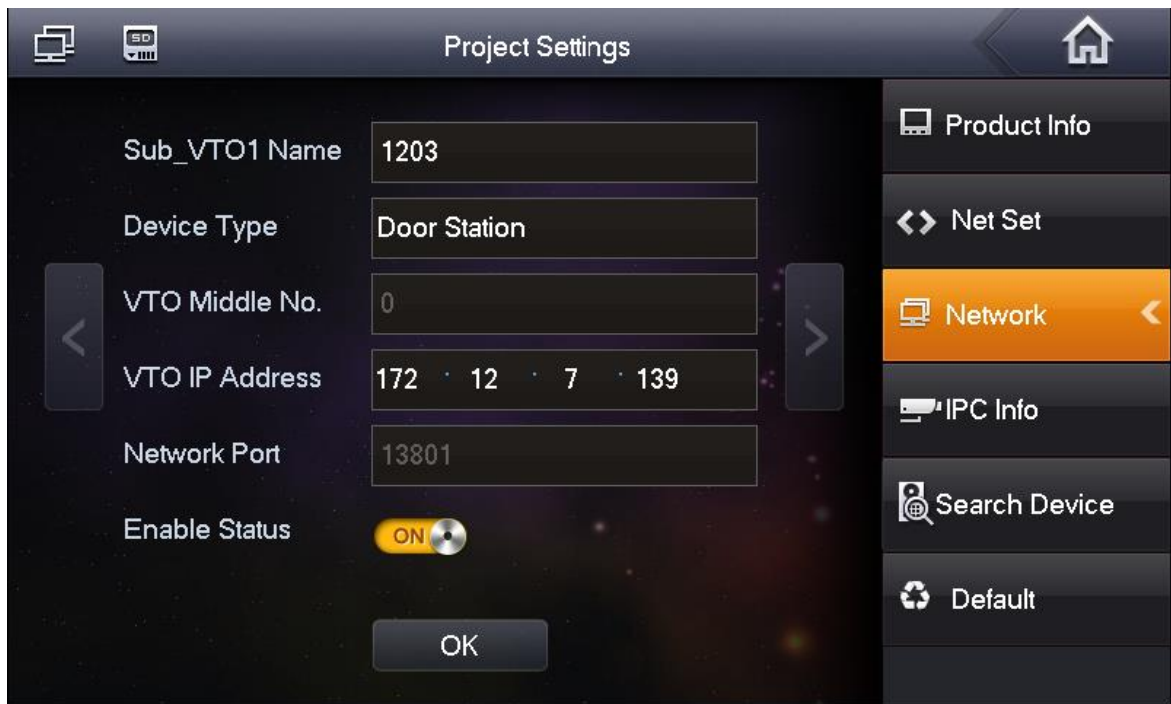



Figure 3-4

If you want to add extension VTO, you can click  to page down. Fill in extension VTO name, extension VTO IP address. Set enable status to ON. You can add more than one extension VTO. See Figure 3-5.

Note:

You can add more than one VTO if you need.

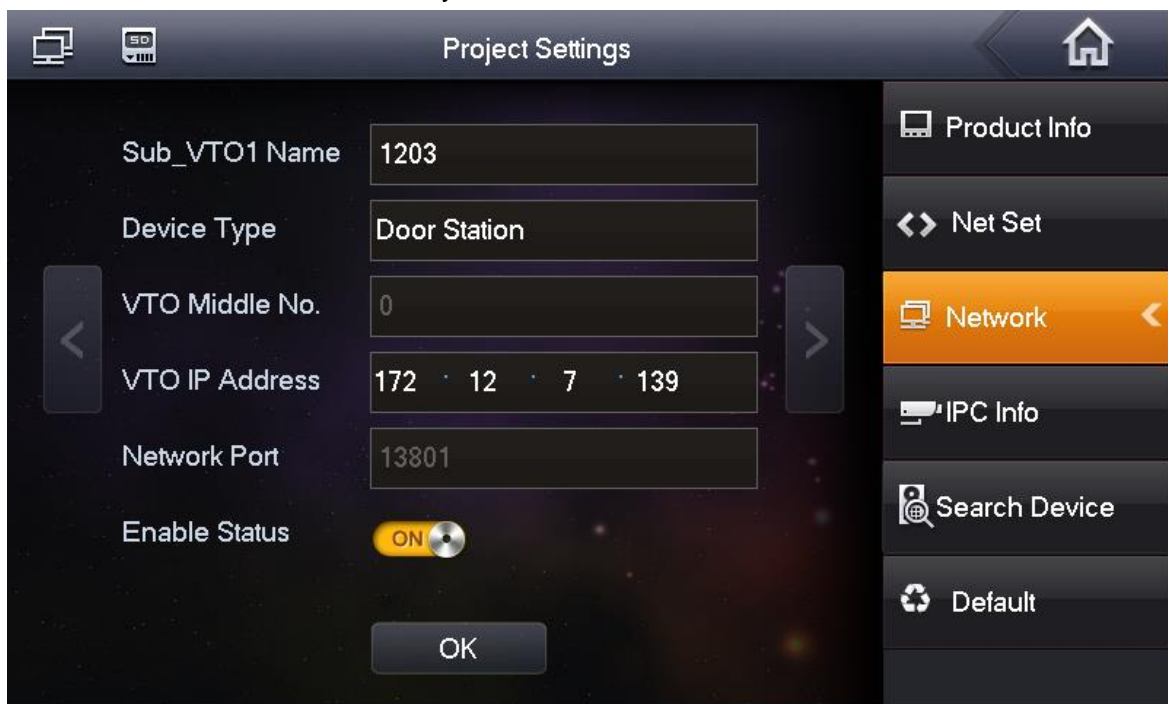

Figure 3-5

Step 6. Click OK.

### 3.3 Config Complete

After config is complete, main VTO call VTH. VTH pops up monitor video and operation buttons. See Figure 3-6.

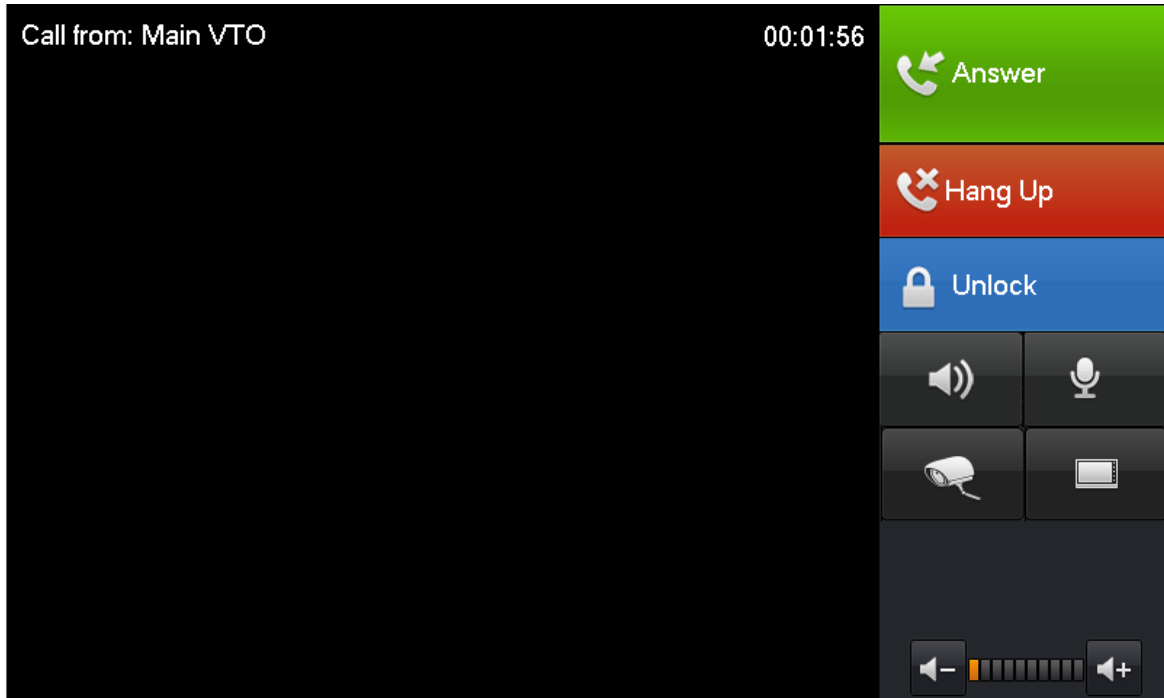







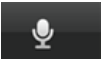







Figure 3-6

Icon	Name	Note
	Accept	Incoming call, click  to accept call.
	Hang up	Incoming call, click  to hang up.
	Unlock	VTH in calling status, click  to unlock corresponding VTO
	Speaker	Used to enable or disable VTH audio output.
	MIC	Used to enable or disable VTH audio input.
	Monitor IPC	Click  to select IPC you want to monitor.
	Switch	<ul style="list-style-type: none"> <li>Monitor VTH, click  to switch to monitor IPC.</li> <li>Monitor IPC, click  to switch to</li> </ul>

Icon	Name	Note
		monitor VTO.
 A volume control icon consisting of a speaker symbol on the left, a horizontal bar with seven orange segments and three grey segments in the middle, and a speaker symbol on the right with a plus sign.	Volume	Adjust VTH volume.

Chart 3-1





# 4 Product Function

## 4.1 Homepage

Product homepage includes four menu options, as Video Talk, Security, Message, and Settings. See Figure 4-1.



Figure 4-1

No.	Name	Note
1	Status Bar	 : Network connection icon. It means network connection is normal.  : VTO not connected. It means device does not connect to any VTO.  : SD card. It means the device has plugged in SD card. Not shown, means SD card is not plugged in.  : DND icon . It means device enable DND (do not disturb) function.





		 : Missed icon. It means user has missed message.
2	Time	Show date, week and time.
3	Video Talk	In this page you can view all call records.
4	Alarm	Set zone type, status, delay time, zone switch and etc. of each zone.
5	Message	You can view, delete and clear announcements and alarm info, plus guest message and etc.
6	Project Setup	Click this icon, to enter project setup.
7	Arm	Click this icon to enter arm mode.

Chart 4-1

## 4.2 Settings

In Settings interface you can set VTH password, ring, DND, talk and etc. as well as view product introduction and version.

### 4.2.1 User Settings

Click on  **User Settings**, you can set password, ring, talk, DND, local IPC, clean, touch ring, SD card and snapshot plus restore default settings. See Figure 4-2.

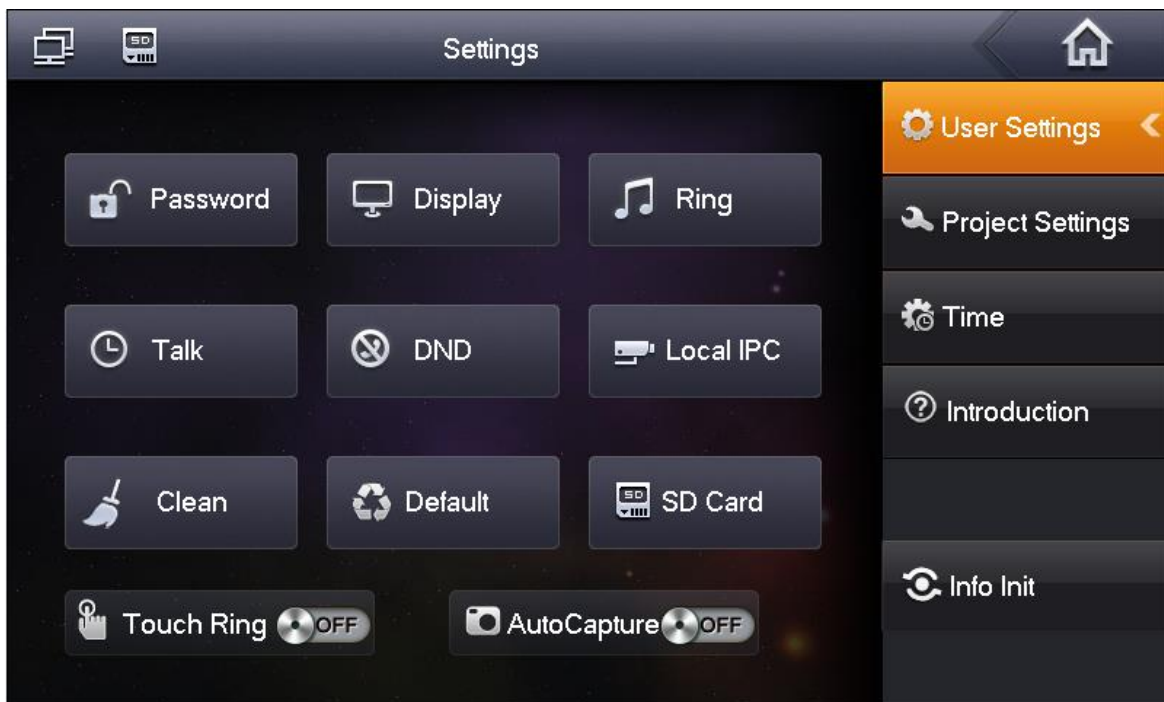
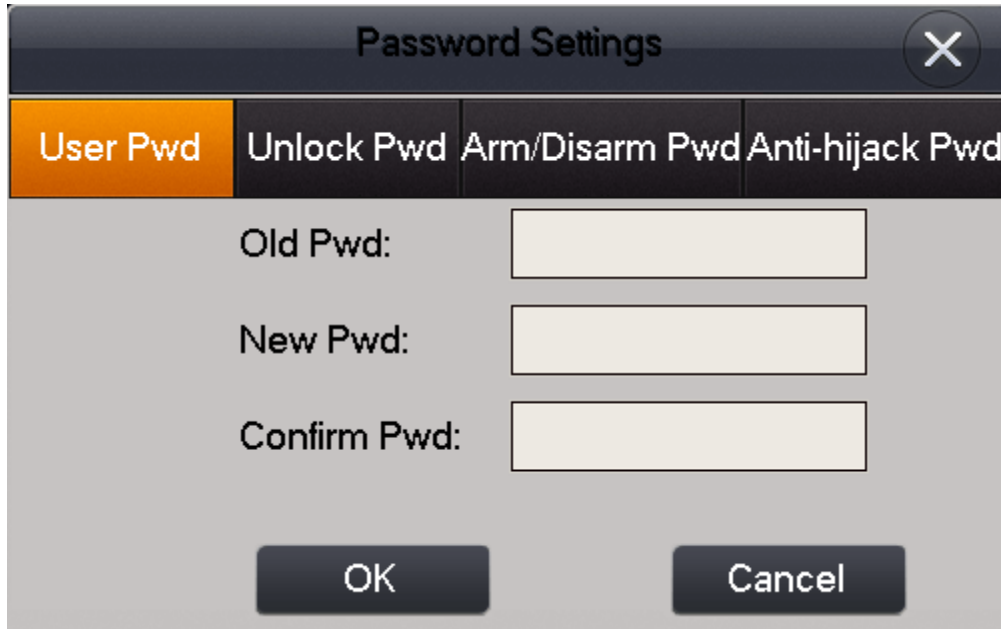

Figure 4-2

#### 4.2.1.1 Password

You can go to Settings>User Settings>Password Settings interface, set username password, unlock password, arm/disarm password and duress(anti-hijack) password.

Step 1. Click Settings>User Settings>Password Settings. See Figure 4-3.



The image shows a 'Password Settings' dialog box. It has a title bar with a close button (X). Below the title bar are four tabs: 'User Pwd' (highlighted in orange), 'Unlock Pwd', 'Arm/Disarm Pwd', and 'Anti-hijack Pwd'. The 'User Pwd' tab is active and contains three input fields: 'Old Pwd:', 'New Pwd:', and 'Confirm Pwd:'. At the bottom of the dialog are two buttons: 'OK' and 'Cancel'.

Figure 4-3

Step 2. Select password type.



Step 3. Enter old password, new password and confirm password.

Note:

- User password initially is 123456.
- Unlock password initially is null.
- Arm password initially is 123456.
- Disarm password initially is 123456.
- Anti-hijack password initially is 654321.

Step 4. Click on OK when you complete.

#### 4.2.1.2 Display

You can go to Settings>User Settings>Display Settings, You can set screen brightness and screensaver via  and . Click OK to save.

#### 4.2.1.3 Ring

You can go to Settings>User Settings>Ring Settings, select incoming call ring and alarm ring.

You can set call ring, alarm ring and volume via **+** and **-**.

#### 4.2.1.4 Talk

You can go to Settings>User Settings>Talk Settings. You can set VTH ring time, VTH ring time, VTH talk time, VTH talk time, monitor time and VTO message time via **+** and **-**. See Figure 4-4.



Figure 4-4

Note:

- VTO calls VTH, VTH ring time can be set up to 120s. VTO message time supports (0~90) s. When you set message time to 0s, you will be unable to leave message.
- VTO calls VTH, VTH ring time is set to 15s. If VTO message time is set to 0s, then when VTO calls VTH, the call is not accepted for over 15s, VTO auto hangs up. If VTO message time is not 0s, then when VTO calls VTH, the call is not accepted for over 15s, VTO will be asked if to enter message mode.

#### 4.2.1.5 DND

Select Settings>User Settings>DND.

See Figure 4-5.

Note:

- Effective immediately after setup.
- DND is disabled by default. DND hour is 0H by default.
- After DND is ON, incoming call ring will not be prompted, and you can view missed call record in Video Talk<Record<Missed.

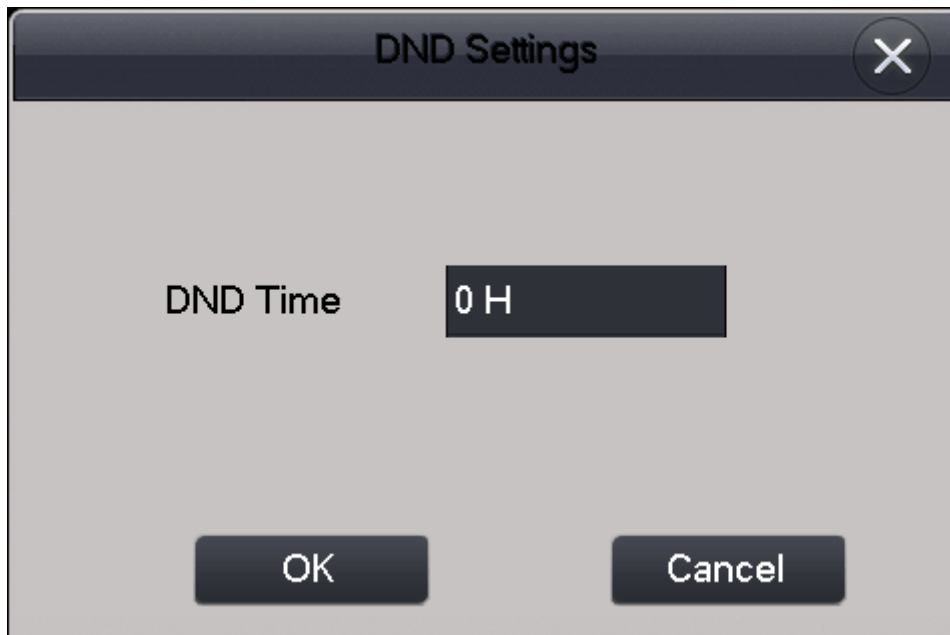

Figure 4-5

#### 4.2.1.6 Local IPC

Max support 8-ch of IPC.

Select Settings>User Settings>Local IPC.

Step 1. Click on Local IPC. You can set IPC name, address, username and password. See Figure 4-6.

Figure 4-6

Step 2. Set IPC.

Parameter	Note
IPC Name	Enter IPC name.
Network Address	Enter planned IPC IP address
Username	Enter login IPC WEB username and password
Password	
Port	IPC port no.
Protocol	As local protocol and Onvif protocol, please select accordingly.
Stream Type	According to need select stream type, main stream and sub stream. <ul style="list-style-type: none"> <li>• Main stream</li> <li>• Sub stream</li> </ul>
Monitor Channel	Ad IPC and NVR. <ul style="list-style-type: none"> <li>• To monitor channel, select IPC: means VTH get IPC video stream.</li> <li>• To monitor channel, select NVR: means IPC connects to NVR, VTH get IPC video stream via NVR.</li> </ul>

Chart 4-2

Step 3. Click on Save to complete.

Note:

- Click Monitor to add IPC monitored.

- Click  to continue to add local IPC, up to 8.

#### 4.2.1.7 Clean

Select Settings>User Settings>Clean. Click on Clean to lock screen and now you can clean the screen.

#### 4.2.1.8 SD Card

Note:

- Only when you insert SD card, this function is shown.
  - Enter SD card setup, verification code is user password, initial password is 123456.
- You can go to Settings>User Settings>SD Card interface, click SD Card, to view remaining space or format SD card.

#### 4.2.1.9 Default

Step 1. Select Settings>User Settings>Default.

Step 2. Enter password, click OK.

Note:

This verification code is user password. You can set in Settings>User Settings>Password. Default is 123456.

Step 3. Click OK. Device will reboot, please wait.

#### 4.2.1.10 Touch Ring

Slide . ON means touch sound is on. OFF means touch sound is off.

#### 4.2.1.11 Auto Snapshot

Slide , ON means to enable auto snapshot. OFF means to disable auto snapshot. During video talk, it auto snapshots three pictures which can be viewed in Info Search.

## 4.2.2 Project Settings

Click on **Project Settings**, this function is for installer user only. The entry password is 888888.

### 4.2.2.1 Product Info

#### Warning

**VTH room no. must match VTH short no. on VTO WEB. You can set local VTH room no. in Setting>Project Settings>Product Info.**

- Local device is master VTH

Step 1. Select Settings>Project Settings>Product Info.

See Figure 4-7.

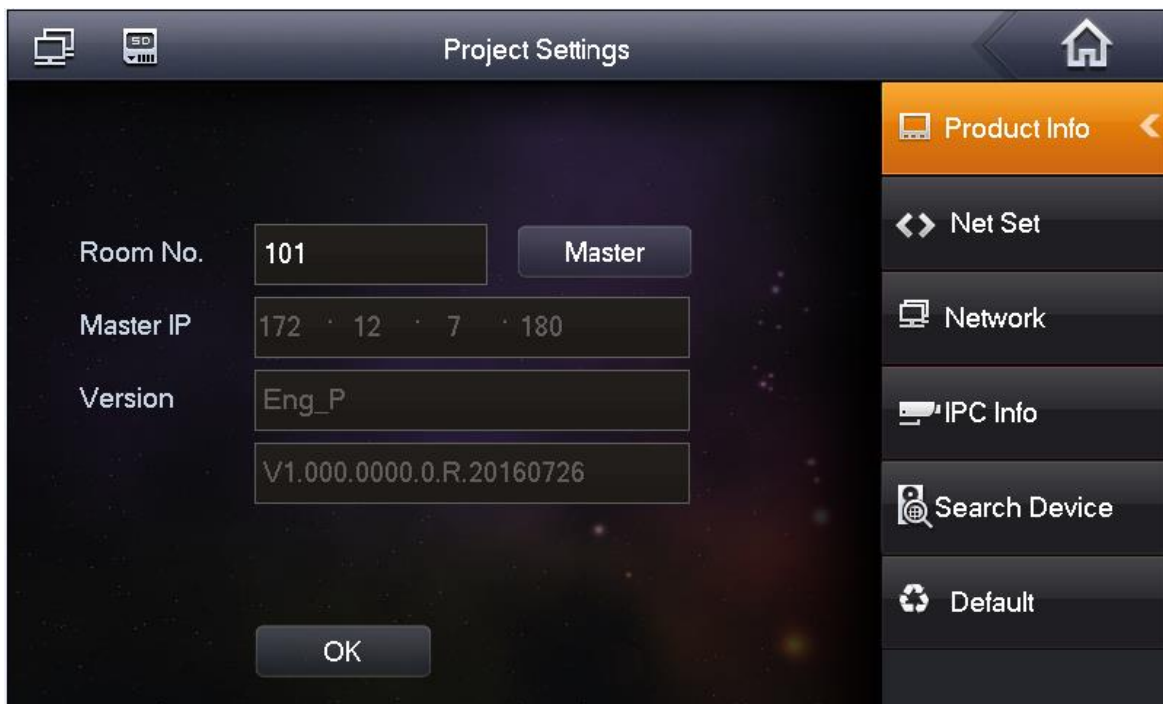

Figure 4-7

Step 2. Fill in room no.

Step 3. Click OK.

- Local device extension

Step 1. Select Settings>Project Settings> Product Info. See Figure 4-8.

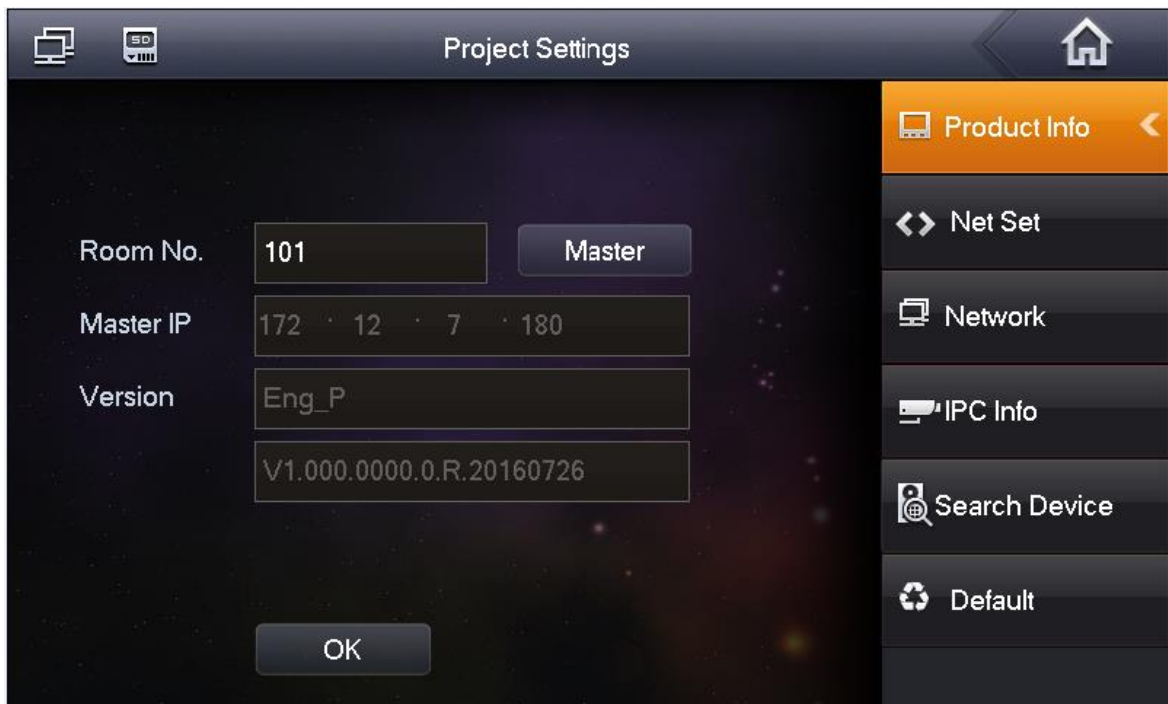

Figure 4-8

Step 2. Click Master. See Figure 4-9.

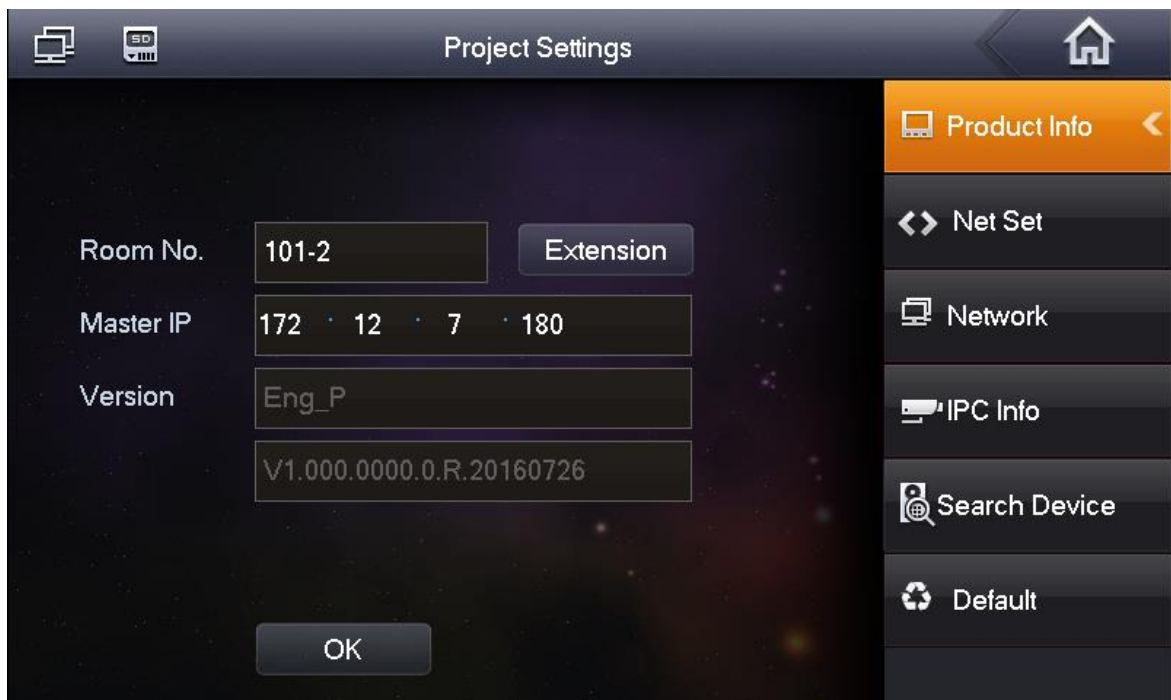

Figure 4-9

Step 3. Fill in room no. and host IP.

Note:

Part of extension info will be auto synced with master VTH, and cannot be modified.

Step 4. Click OK to save.



#### 4.2.2.2 Network

You can select Settings>Project Settings>Network>, set VTH device network.

Step 1. Select Settings>Project Settings>Network.

Step 2. Select method of network.

- Select Static, manually enter device IP, subnet mask, gateway and etc.
- Select DHCP, auto get network parameters.

Note:

Telnet server is ON, debugging personnel can login via telnet+IP view to view VTH config.

#### 4.2.2.3 Network Terminal

You can select Settings>Project Settings>Network Terminal, manually add VTO info.

Step 1. Select Settings>Project Settings>Network Terminal. See Figure 4-10.

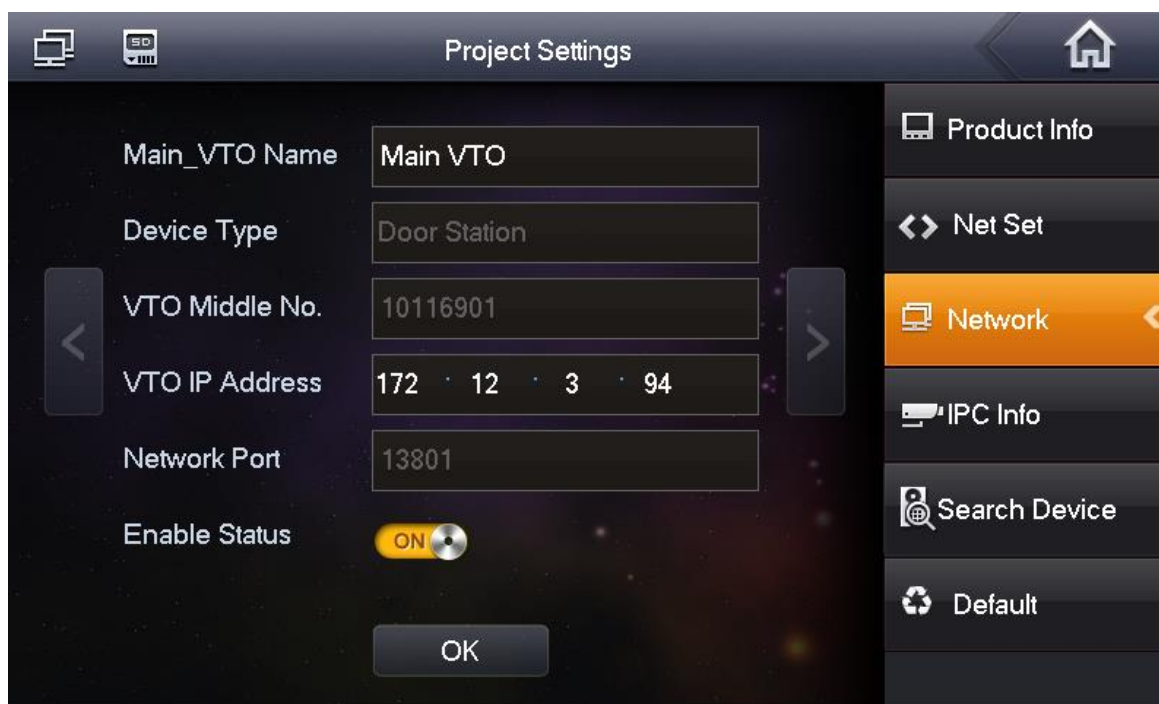



Figure 4-10

Step 2. Fill in VTO name, VTO IP address, and set Enable Status to ON.

Step 3. Click OK. You can click  to page down, fill in sub VTO name, device type and VTO IP address. Set enable status to ON, see Figure 4-11.

Note:

You may add more than one sub VTOs.

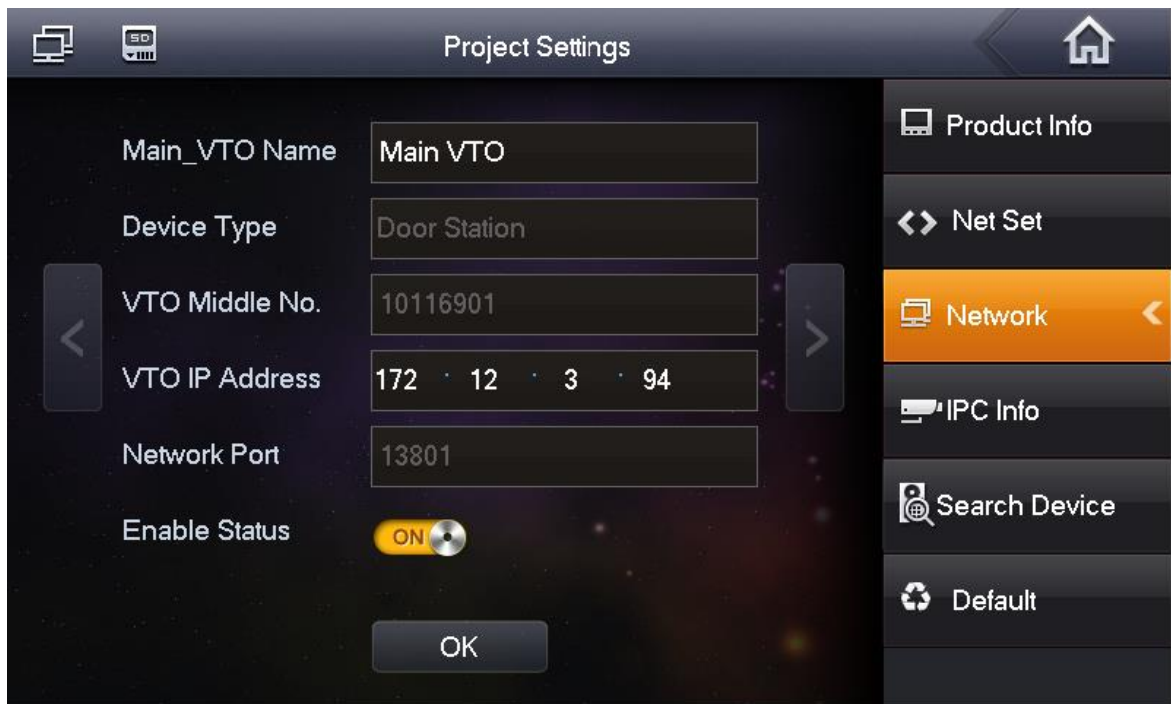

Figure 4-11

#### 4.2.2.4 IPC Info

VTH device auto sync with IPC info added on VTO (max 24), used for VTH to monitor the IPC. You can view in Settings>Project Settings>IPC Info.

#### 4.2.2.5 Search Device

##### Note

- Our 2-wireVTH and villa VTO are in the same segment by default, if you have modified VTH IP address, please set it back to default IP.
- Device search function is usually on villa VTO, not recommended for unit VTO.
- Ensure room no. set on VTH is the same as VTH on VTO, otherwise call will not work.

You can go to Settings>Project Settings>Device Search, search online device in the same segment with VTH, you can add or modify VTO via search.

##### Note:

Support to modify vial VTO IP, not unit VTO.

Step 1. Select Settings>Project Settings>Device Search. See Figure 4-12.

##### Note:

Click Refresh to refresh result.

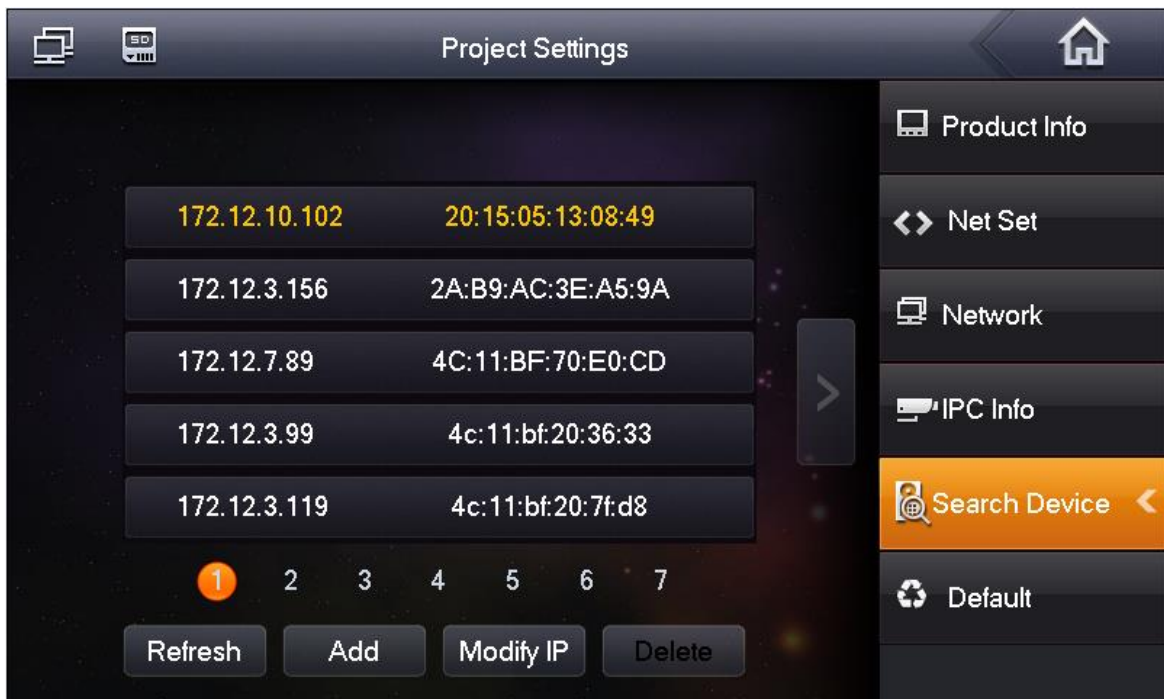

Figure 4-12

Step 2. Select villa VTO, click Modify IP.

See Figure 4-13.

Note:

When modify IP is grey, means the device is unit VTO, cannot change IP.



Figure 4-13

Step 3. Fill in IP address, subnet mask and gateway of villa VTO, click OK.

Step 4. Click Add.

Step 5. Fill in VTO name, set status to ON.

You also can click  to page down. The villa VTO is set as sub VTO, set status to ON. See Figure 4-14.



Name	Main VTO
Channel	Vto0
Mid Num	10116901
IP	172.12.3.94
Port	554
State	On
Searched IP	172.12.10.102

OK

Figure 4-14

Step 6. Click OK. Now, villa VTO can call the VTH.

#### 4.2.2.6 Default

You can go to Settings>Project Settings>Default, restore all config info to default in Project Settings interface.

Note:

Device will reboot after restoration.

### 4.2.3 Time Settings

You can select Settings>Time Settings, set device system date and time, click OK, see Figure 4-15.

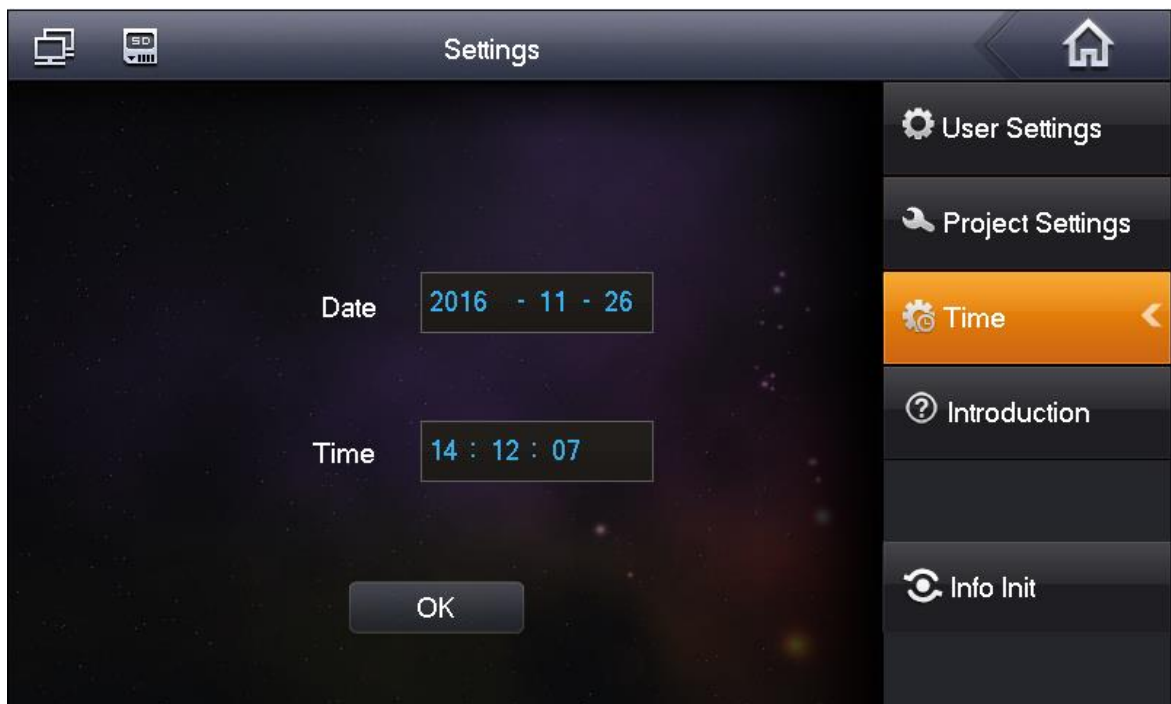

Figure 4-15

#### 4.2.4 Introduction

You can select Settings>Introduction, see Figure 4-16.



Figure 4-16

#### 4.2.5 Info Initialization

You can go to Settings>Initialization interface.

Note:

This is for apartment system.

Step 1. Select Settings>Initialization. See Figure 4-17.

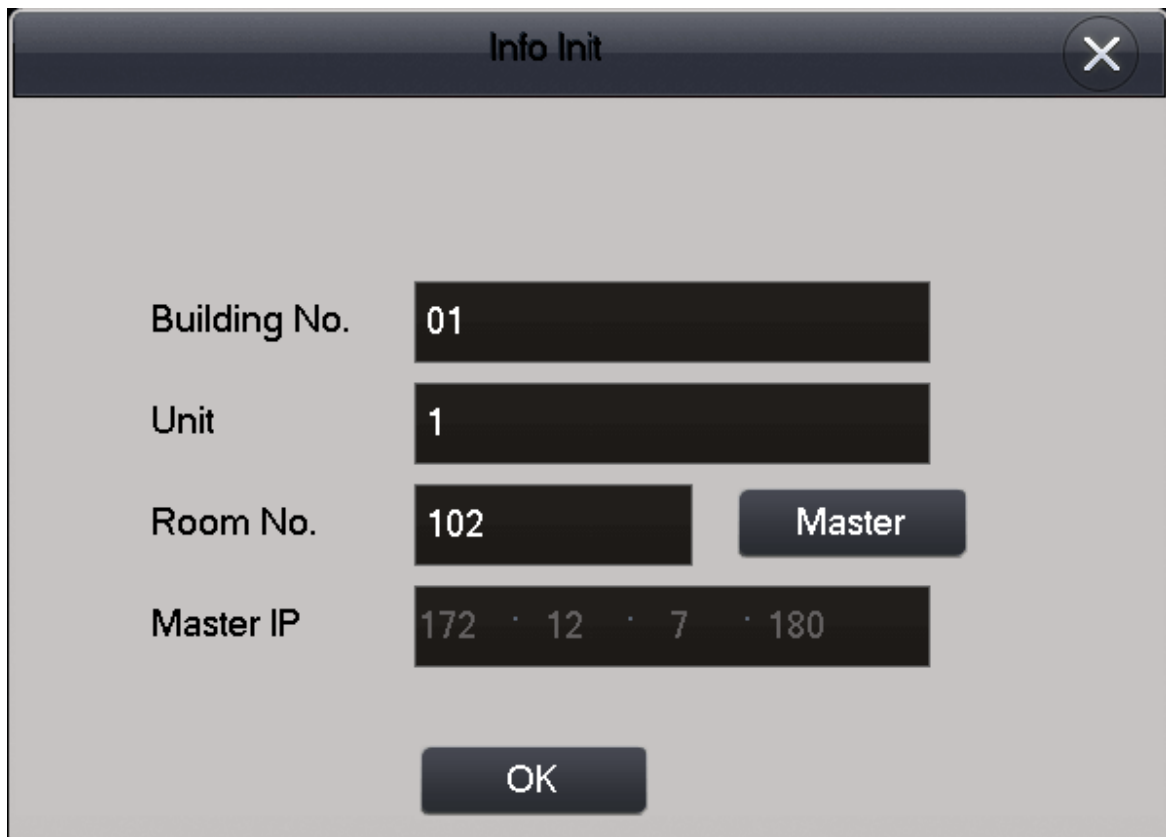

The screenshot shows a dialog box titled "Info Init" with a close button in the top right corner. The dialog contains the following fields and controls:

- Building No.:** A text input field containing the value "01".
- Unit:** A text input field containing the value "1".
- Room No.:** A text input field containing the value "102" and a "Master" button to its right.
- Master IP:** A text input field containing the IP address "172 · 12 · 7 · 180".
- OK:** A button at the bottom center of the dialog.

Figure 4-17

Step 2. Enter building, unit, and room no.

You can select extension, enter building, unit, room no. and host IP to add VTH extension.

Step 3. Click OK.

## 4.3 Call

Note:

- Call function is used in VTH calling VTH.
- If two residential VTH both have cameras, then a bidirectional video talk can be performed.

### 4.3.1 Call Resident

#### 4.3.1.1 Call User

Step 1. Select Call>Call User, see Figure 4-18.



Figure 4-18





Parameter	Note
Alarm Output	 Slide  , ON means alarm output is enabled, and OFF means alarm output is disabled. When other device calls VTH, it will link to 1-ch alarm output on VTH.
Inter-resident Call	 Slide  , ON means to enable inter-resident call. OFF means to disable inter-resident call. Note: If inter-resident call is disabled, then VTH in other room cannot call this VTH.

Chart 4-3



Step 2. Enter room no. of user you want to call, click  when he/she accepts call, you can have a bidirectional talk.

Note:

- If call user is building 1, unit 1, and room 101, enter 1-1-101 for room no.
- If master VTH (101), calls extension (101-1), then enter room no. :-1. If extension VTH calls master VTH, then enter 101.

#### 4.3.1.2 Call via Contact

### Warning:

You must add contact first before you can call designated resident via contact. Please refer to Ch 4.3.2.

Step 1. Select Video Talk>Call Resident.

Step 2. Click  to open Contacts.

Step 3. Select resident you want to call, click  to call.

### 4.3.2 Contact

You can select Video Talk>Call Resident, to add, call, modify, delete and cleat contact.

#### 4.3.2.1 Add Contact

Step 1. Select Video Talk>Call Resident.

Step 2. Click . See Figure 4-19.

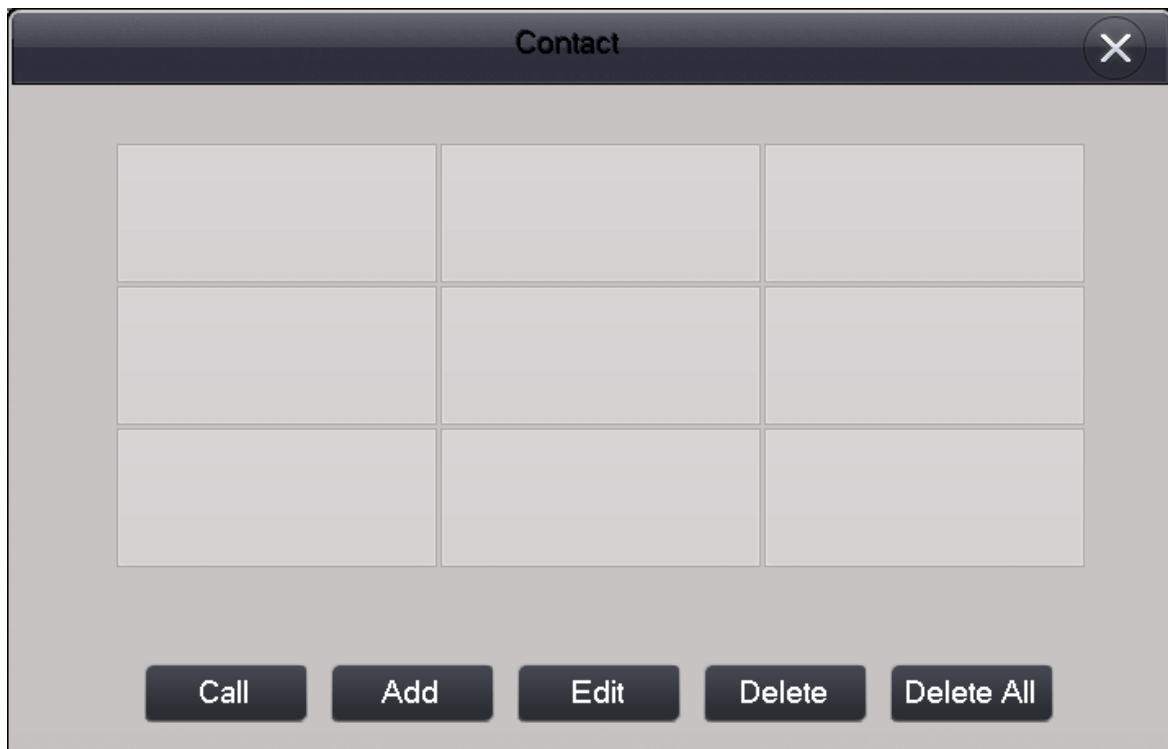

Figure 4-19

Step 3. Click Add. Device shows User Info page. See Figure 4-20.

Tips:



You also can click any block in Contact interface, device shows user info interface.

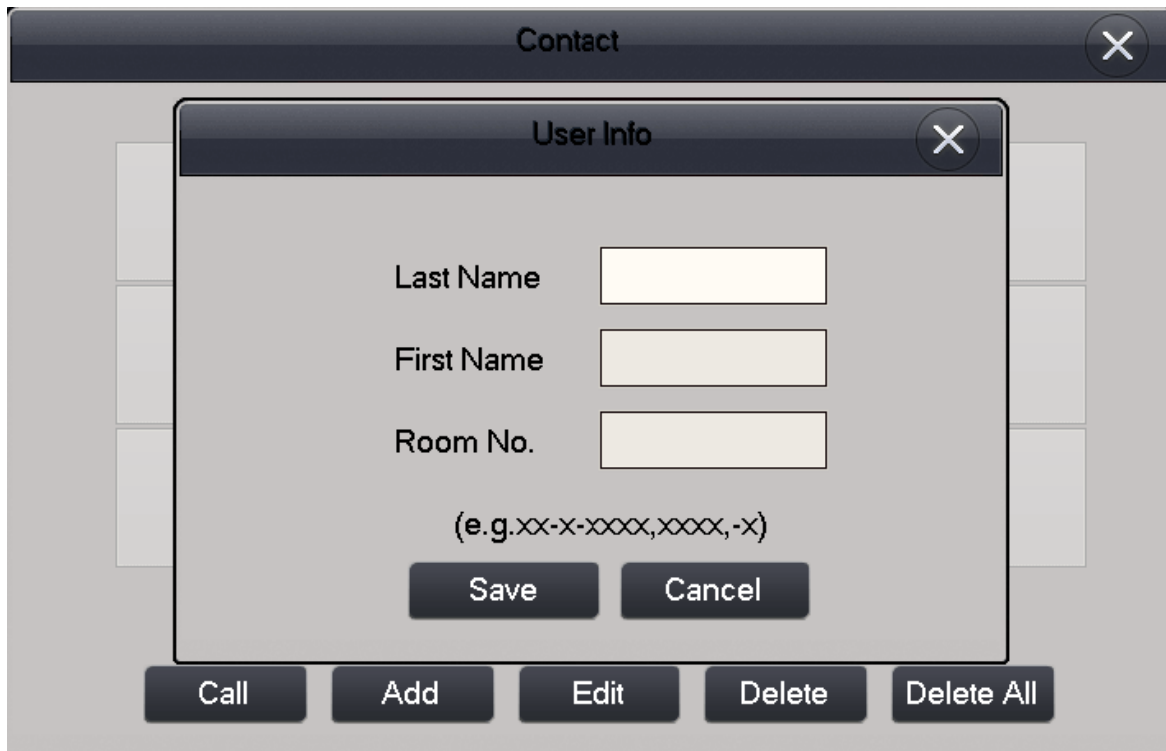

Figure 4-20

Step 4. Enter contact name and room no.

Step 5. Click OK to add contact. See Figure 4-21.

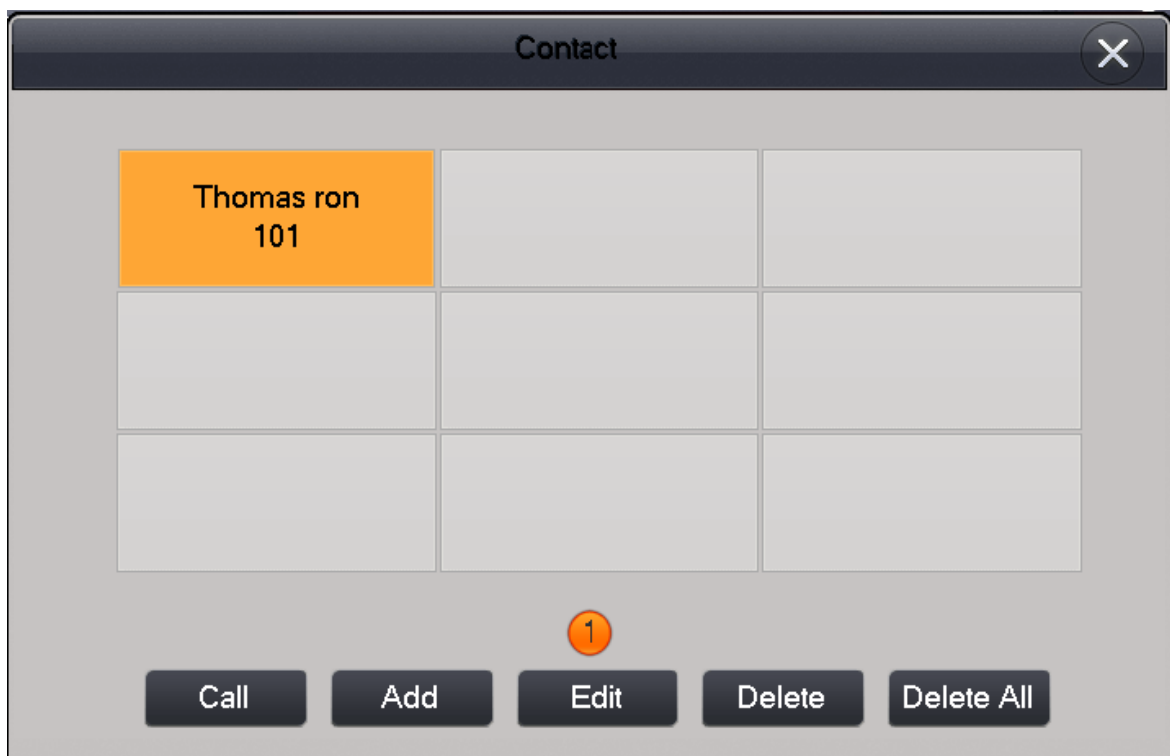

Figure 4-21

#### 4.3.2.2 Call Contact

In Contact interface, select user you want to call, click Call.

#### 4.3.2.3 Modify Contact

In Contact interface, select user you want to modify, click Edit.

#### 4.3.2.4 Delete Contact

In Contact interface, select user you want to delete, click Delete.

#### 4.3.2.5 Clear Contact

If you want to clear all contacts, in Contact interface, click Clear and confirm in pop-up box.

### 4.3.3 Call Record

You go to Video Talk>Call Record interface, or click  on device front panel to view, store, delete or clear VTH call record, and call back missed call. See Figure 4-22.

Note:

Do not support call back and storage of VTO and center call record.

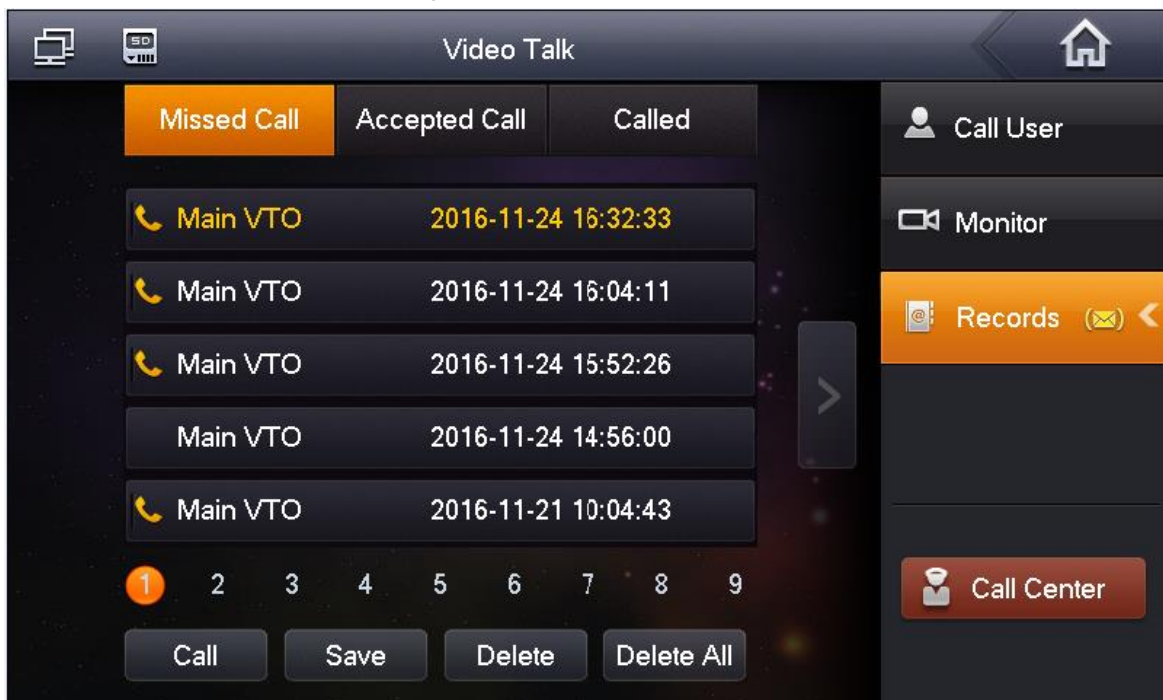

Figure 4-22

#### 4.3.3.1 Call Back

If you want to call back, select number to call, click Call.

#### 4.3.3.2 Storage

If you want to store contact, select number to store, click Save. Enter contact name. See Figure 4-23.



Figure 4-23

#### 4.3.3.3 Delete, Clear

You can select call record, click Delete to delete it.  
You also can click Clear to delete all records.

### 4.4 SOS Call

In case of emergency, click SOS on device front panel or  button in interface to call MGT

center or click  **Call Center** to call MGT center. See Figure 4-24.

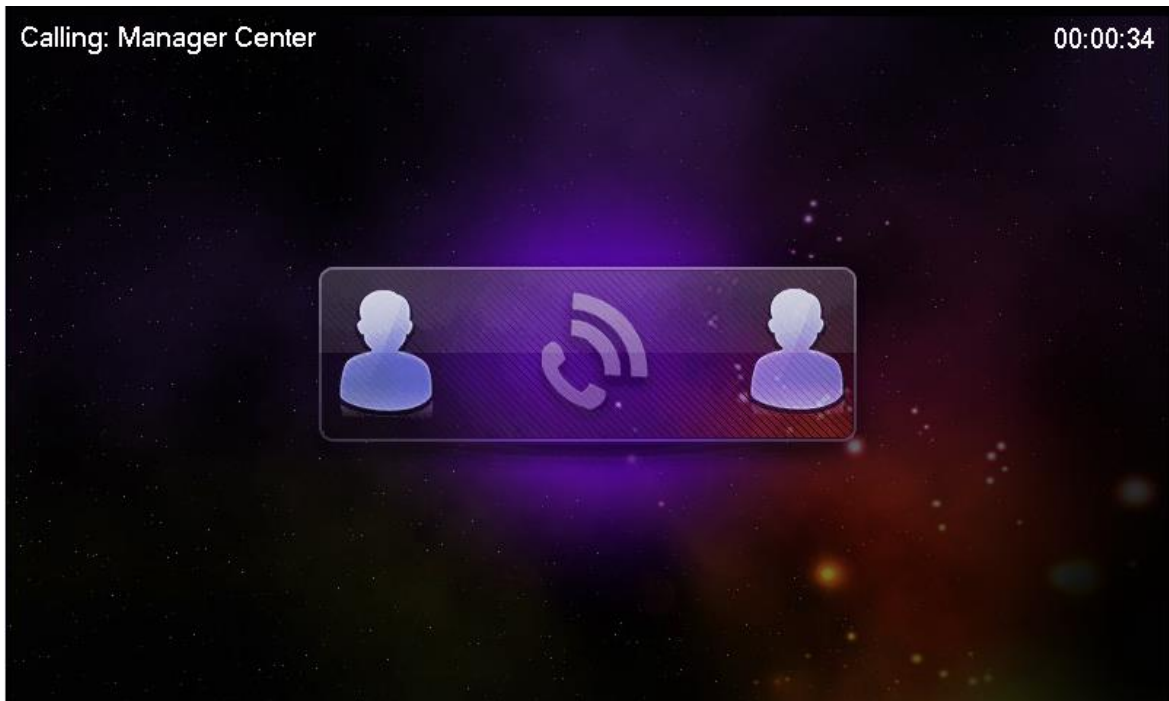



Figure 4-24

## 4.5 Monitor

VTH can monitor VTO or any specific IP camera. Under monitor status, press  on front panel to call VTO. When it calls VTO, call will be auto accepted.

For example, monitor VTO:

Step 1. Select Video Talk>Monitor>VTO, or click  on device front panel. See Figure 4-25.

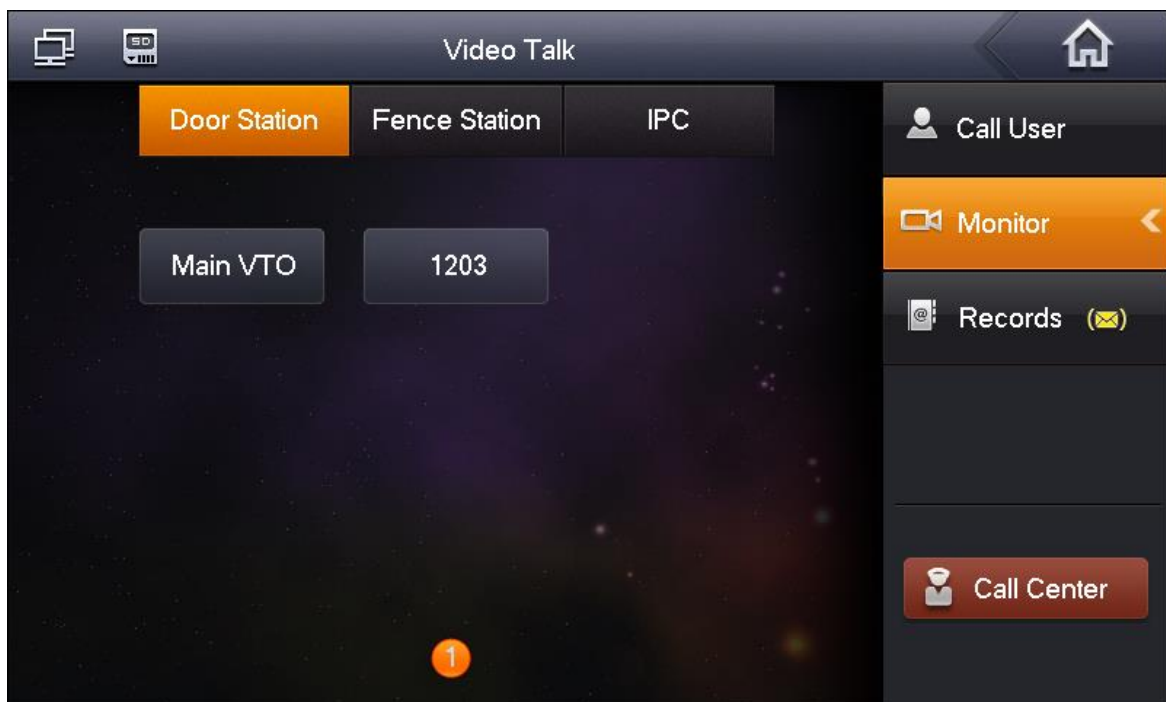

Figure 4-25

Step 2. Select VTO to monitor. See Figure 4-26.

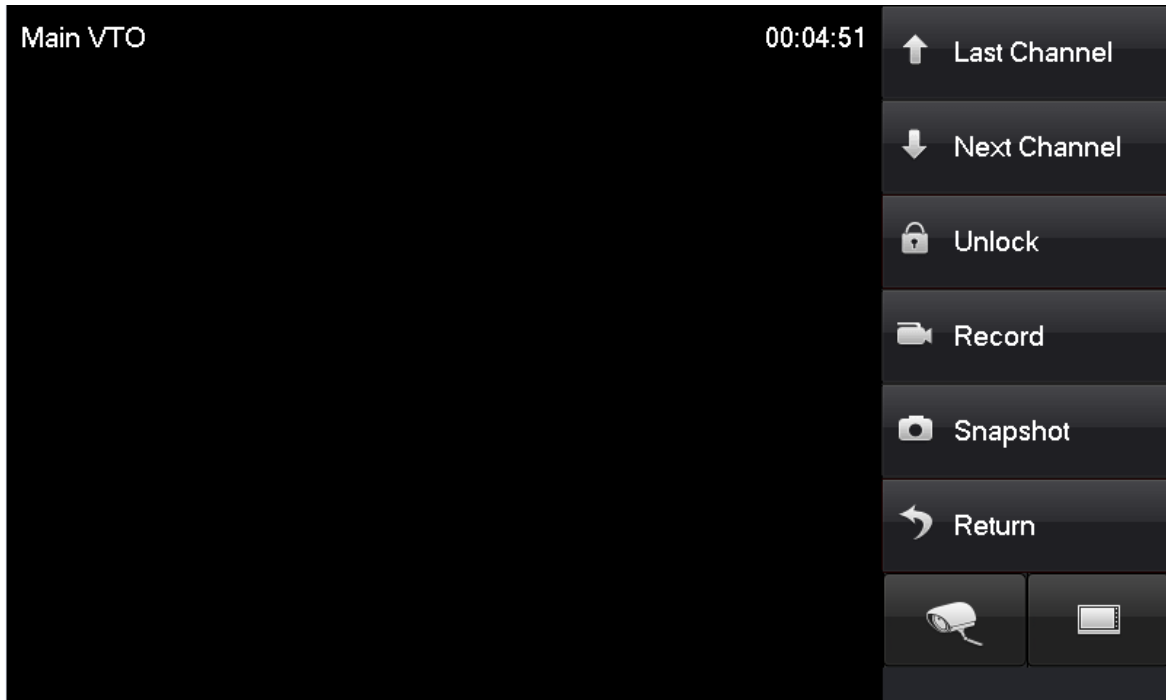

Figure 4-26

Icon	Note
	Switch to monitor previous channel or next channel VTO.
	Unlock key, can remotely unlock VTO.
	Record, click  to start record, click  again to end record.
	Snapshot, click  to snapshot two pictures.
	Return, can return to previous menu.
	Click  to select IPC to monitor.
	<ul style="list-style-type: none"> <li>• When monitor VTO, click  to switch to monitor IPC.</li> <li>• When monitor IPC click  to switch to monitor VTO.</li> <li>•</li> </ul>

Chart 4-4

## 4.6 Alarm

### 4.6.1 Zone Setting

VTH supports 8-ch alarm zone setup.

Note:

Only under disarm status can set alarm zone.

You select Alarm>Zone Status interface, to set each zone type, status, delay time and etc.

Step 1. Select Alarm>Zone Status. See Figure 4-27.

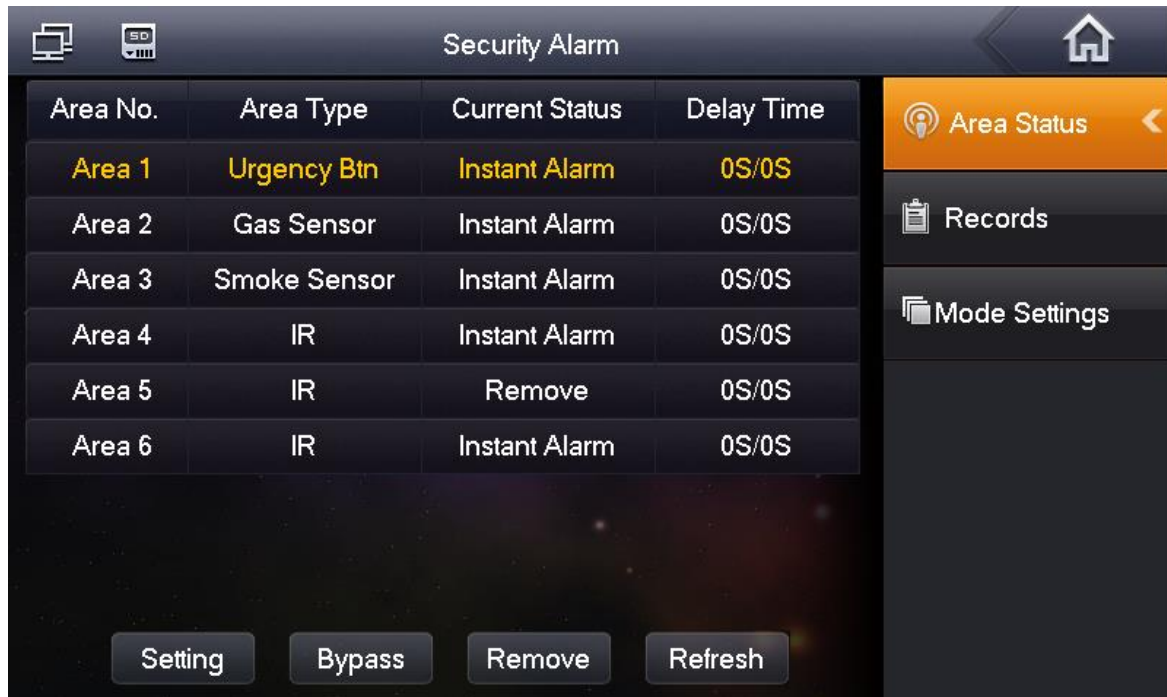

Figure 4-27

Parameter	Note
Setup	Set zone, including zone type, NO/NC, alarm, entry delay and exit delay.
Bypass	Zone is shielded during this arming, when device disarms, zone will restore status before bypass.
Delete	Zone shielded during arming/disarming.
Refresh	Refresh zone.

Chart 4-5

Step 2. Click Setup, select zone to set.

Step 3. Enter arm password, it is 123456 by default.

Note:

You can go to Settings>User Settings>Password Settings to change arm/disarm password.

Step 4. Click OK. See Figure 4-28.

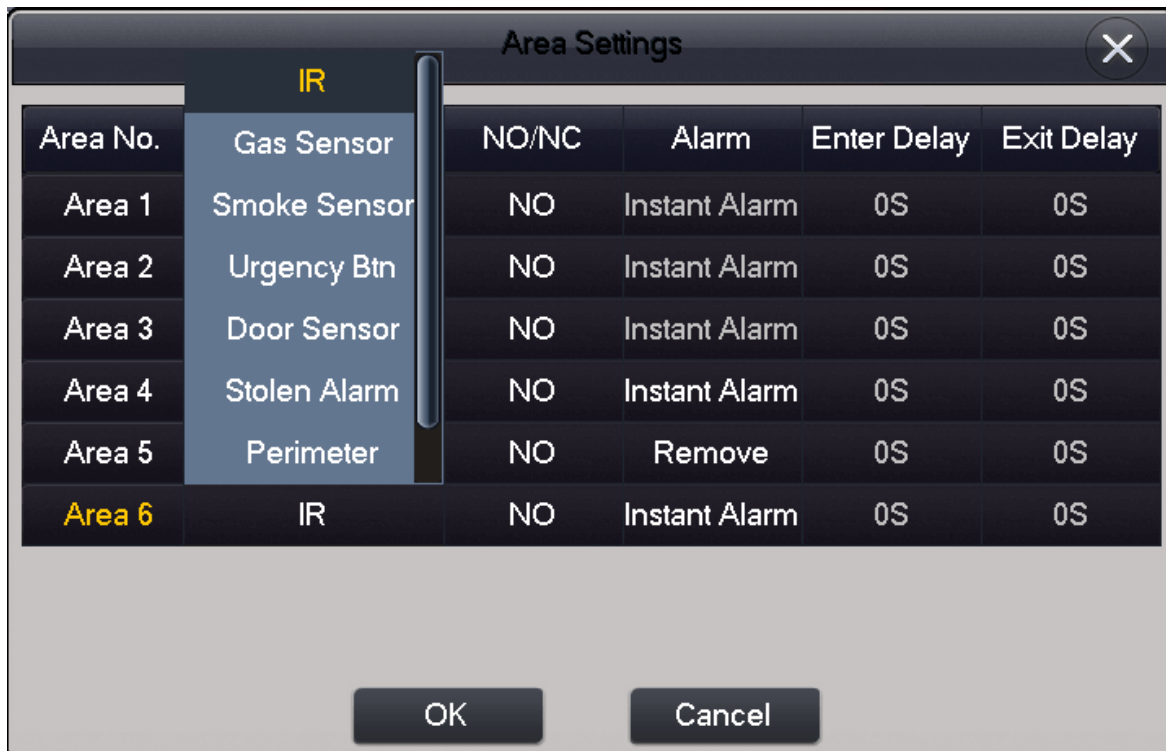

Figure 4-28

Step 5. Set zone type, NO/NC, alarm, entry delay and exit delay.

Parameter	Note
Zone No.	Set sensor zone no., not changed by default.
Zone Type	According to each zone sensor type, select zone type, including IR, gas, smoke, SOS and etc. Note: By default zone 1 to 3 cannot set zone type.
NC/NO	According to sensor type, select NO and NC, must match sensor type.
Alarm	Alarm status are as instant alarm, delay alarm, bypass and remove.
Entry Delay	When alarm is triggers, if you do not disarm within the delay time, it will not alarm. If you do not disarm, then it will alarm after delay time. Note: Only available when delay alarm.
Exit Delay	After arm is set, alarm is invalid within delay time. .

Step 6. Click OK.

#### 4.6.2 Mode Setting

You can go to Alarm>Mode, to enable or disable 8 zones for different modes. See Figure 4-29.

Note:

- In disarm status, you can set zone switch status under each mode.
- On is open, OFF is close.

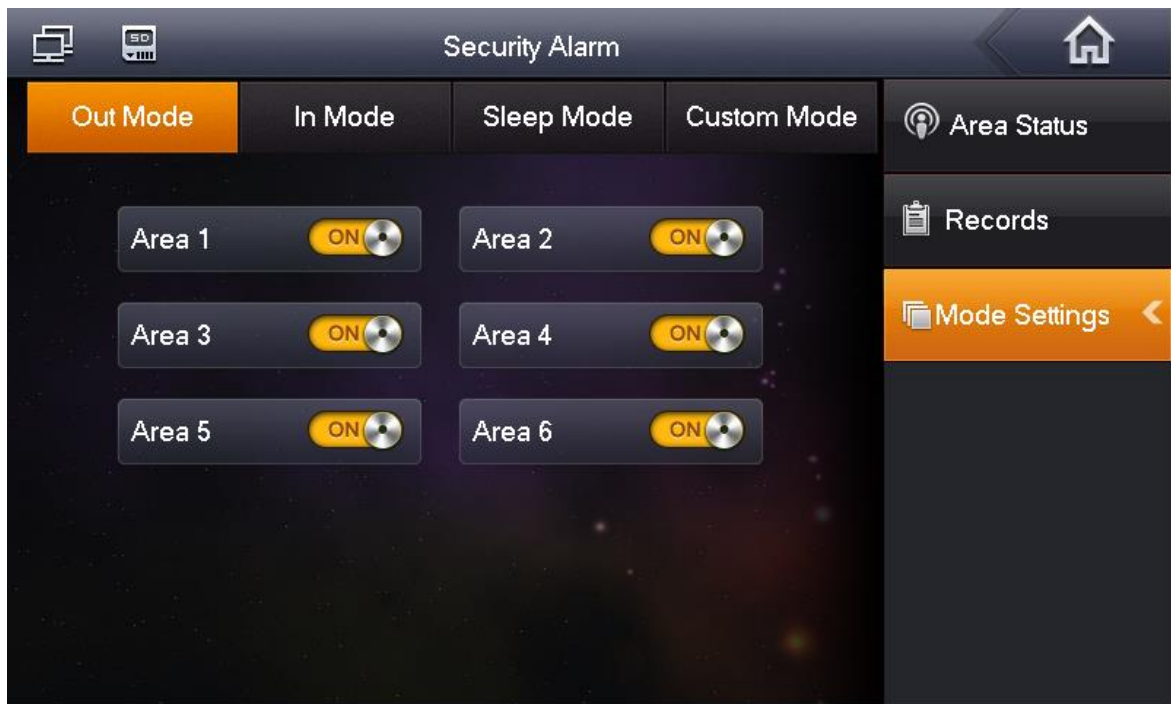

Figure 4-29

### 4.6.3 Arm/Disarm

Arm: When arm is enabled, device enter arming status. When detects alarm, device will alarm and upload alarm.

Disarm: enabled, device exit arming status.

#### 4.6.3.1 Arm

Step 1. In homepage menu, click . See Figure 4-30.





Figure 4-30

Step 2. Select mode.

Step 3. In pop-up interface, enter arm password. Device will beep, which means armed successfully.

Note:

Initial arm password is 123456, and you can change this password in Settings>User Settings>Password Settings.

#### 4.6.3.2 Disarm

Step 1. In homepage, click Disarm icon.

Step 2. In pop-up disarm interface, enter disarm password.

If password is correct, then it will prompt that successfully disarmed. If password is wrong, then it will pop up that password error, please retry.

Note:

Initial disarm password is 123456, and you can change this password in Settings>User Settings>Password Settings.

Warning:

- In emergency, if you are forced to enter disarm password by other, you can enter duress password to stop system work, and the device will auto report alarm to MGT center/platform.
- Default duress password is 654321, and you can change this password in Settings>User Settings>Password Settings.

#### 4.6.4 Alarm Record

When alarm occurs, alarm info not only uploads to Alarm>Alarm Record interface, but also upload to MGT center, and beep for 15s, pop up alarm page.

You can go to Alarm>Alarm Record interface, to view, delete or clear alarm info. See Figure 4-31.

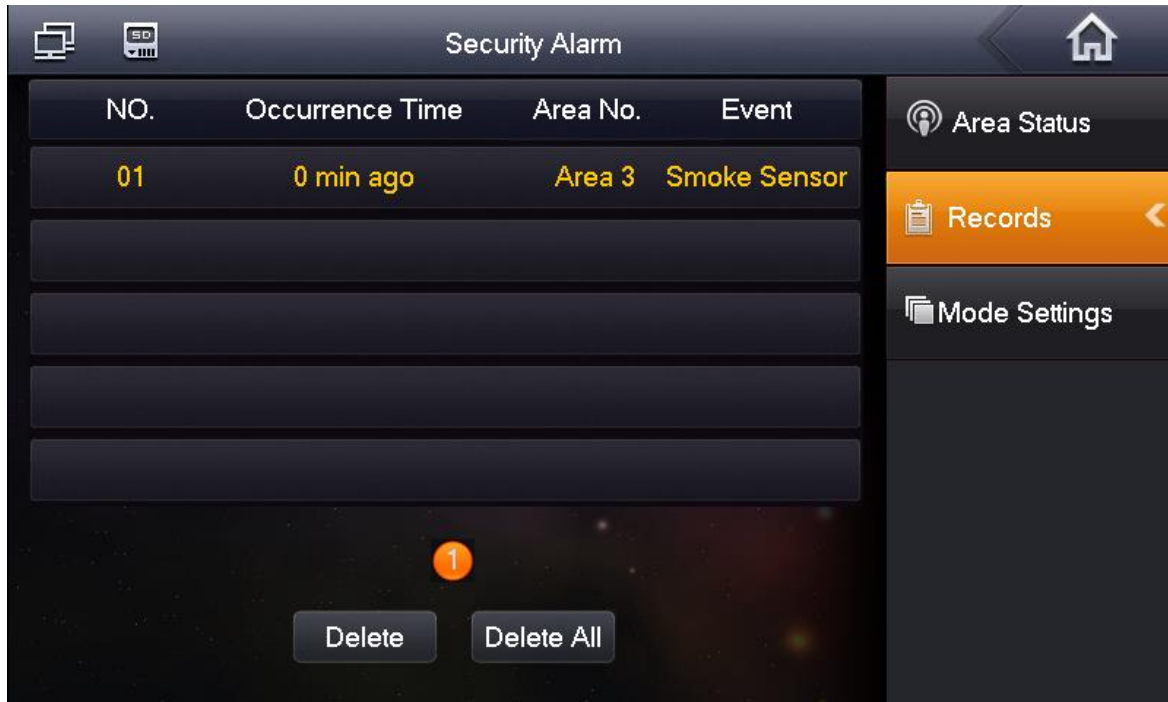

Figure 4-31

#### 4.7 Info Search

You can go to Info Search>Announcement interface, to view, delete and clear announcement, visitor message and record snapshot. See Figure 4-32.

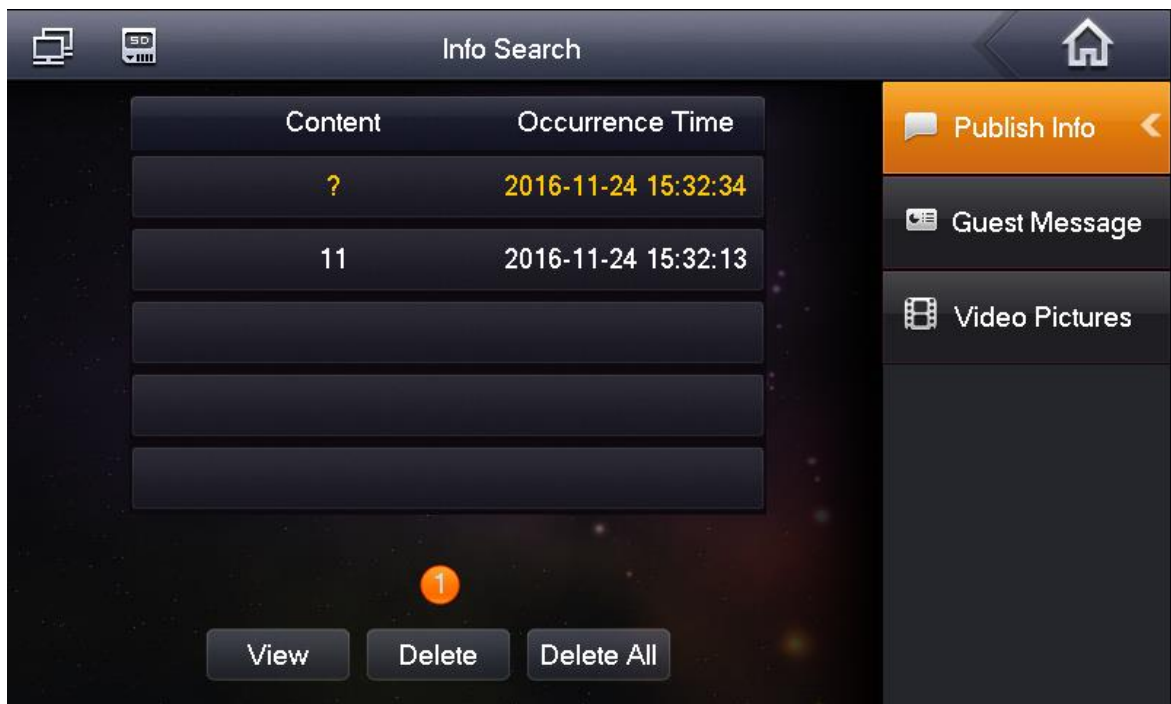

Figure 4-32

## 4.8 Unlock

VTH which is being called, monitored, or calling, press Unlock button on device, to remotely open VTO lock.

# Appendix 1 Technical Specifications

VTH5222CH	
System	
Main Processor	Embedded micro controller
OS	Embedded LINUX OS
Video	
Video Compression Standard	H.264
Video Resolution	800×480
Front Camera	None
Audio	
Input	Omni directional MIC
Output	Built-in speaker
Talk	Bidirectional audio talk
Display	
Screen Dimensions	7 inch TFT full color screen
Operation Mode	
Input	Touch button (SOS, menu, call, monitor, unlock) , touch screen technology
Alarm	
Alarm Input	6-ch alarm inputs
Alarm Output	1-ch alarm output (dry contact)
Network	
Ethernet	10M/100Mbps self-adaptive
Network Protocol	TCP/IP
WIFI	N/A
General	
Power	Special switch direct power supply
Consumption	Standby ≤1.5W; work ≤7W
Work Environment	-10℃~+60℃
Environment	10%~90%RH
Dimensions (L×W×H)	200mm×136mm×22mm
Weight	800g

**Note:**

- **This manual is for reference only. Slight difference may be found in user interface.**
- **All the designs and software here are subject to change without prior written notice.**
- **All trademarks and registered trademarks are the properties of their respective owners.**
- **If there is any uncertainty or controversy, please refer to the final explanation of us.**
- **Please visit our website or contact userr local service engineer for more information.**